

2016

Improved Real Time Predictive Speed Analysis for High Speed Rail Collision Test

Bo Yu

University of Windsor

Follow this and additional works at: <https://scholar.uwindsor.ca/etd>

Recommended Citation

Yu, Bo, "Improved Real Time Predictive Speed Analysis for High Speed Rail Collision Test" (2016). *Electronic Theses and Dissertations*. 5922.

<https://scholar.uwindsor.ca/etd/5922>

This online database contains the full-text of PhD dissertations and Masters' theses of University of Windsor students from 1954 forward. These documents are made available for personal study and research purposes only, in accordance with the Canadian Copyright Act and the Creative Commons license—CC BY-NC-ND (Attribution, Non-Commercial, No Derivative Works). Under this license, works must always be attributed to the copyright holder (original author), cannot be used for any commercial purposes, and may not be altered. Any other use would require the permission of the copyright holder. Students may inquire about withdrawing their dissertation and/or thesis from this database. For additional inquiries, please contact the repository administrator via email (scholarship@uwindsor.ca) or by telephone at 519-253-3000ext. 3208.

Improved Real Time Predictive Speed Analysis for High Speed Rail Collision Test

By

Bo Yu

A Thesis

Submitted to the Faculty of Graduate Studies
through the School of Computer Science
in Partial Fulfillment of the Requirements for
the Degree of Master of Science
at the University of Windsor

Windsor, Ontario, Canada

2016

©2016 Bo Yu

Improved Real Time Predictive Speed Analysis for High Speed Rail Collision Test

by

Bo Yu

APPROVED BY:

Dr. Chunhong Chen
Department of Electrical and Computer Engineering

Dr. Arunita Jaekel
School of Computer Science

Dr. Dan Wu, Advisor
School of Computer Science

December 9, 2016

DECLARATION OF ORIGINALITY

I hereby certify that I am the sole author of this thesis and that no part of this thesis has been published or submitted for publication.

I certify that, to the best of my knowledge, my thesis does not infringe upon anyones copyright nor violate any proprietary rights and that any ideas, techniques, quotations, or any other material from the work of other people included in my thesis, published or otherwise, are fully acknowledged in accordance with the standard referencing practices. Furthermore, to the extent that I have included copyrighted material that surpasses the bounds of fair dealing within the meaning of the Canada Copyright Act, I certify that I have obtained a written permission from the copyright owner(s) to include such material(s) in my thesis and have included copies of such copyright clearances to my appendix.

I declare that this is a true copy of my thesis, including any final revisions, as approved by my thesis committee and the Graduate Studies office, and that this thesis has not been submitted for a higher degree to any other University or Institution.

ABSTRACT

In real train collision test, the test train cabin is required to be propelled on a straight rail, accelerated to a certain velocity, released at a calculated location and finally crash into a barrier with a desired crash velocity, in order to observe the safety performance. Recently, a Real Time Predictive Speed Analysis (RTPSA) method was developed to simulate the whole collision test behavior and calculates the released velocity and location. However, in this method, the train has to be released at the exact calculated velocity when the train is still in acceleration which is very difficult in real test. Moreover, the RTPSA method does not provide a warning mechanism in case the test has to be aborted. In this thesis, two improvements of the RTPSA method are proposed. One is employing the PI controller to force the train operating with an uniform velocity before release, in order to reduce the difficulty of release in real test. The other one is early safety warning which provide upper bound of velocity, before the test, indicating the last chances to abort the test with least losses in different conditions.

AKNOWLEDGEMENTS

I would like to present my gratitude to my supervisor Dr. Dan Wu for his valuable assistance and support.

I also would like to express my appreciation to Dr. Chunhong Chen and Dr. Arunita Jaekel. Thank you all for your valuable comments and suggestions to this thesis.

Meanwhile, I want to thank my lab-mates for helpful discussions and advice. Finally, I thank my parents, my girlfriend and my friends who give me consistent help over the past three years.

TABLE OF CONTENTS

DECLARATION OF ORIGINALITY	III
ABSTRACT	IV
AKNOWLEDGEMENTS	V
LIST OF TABLES	VIII
LIST OF FIGURES	IX
I Introduction	1
1 Introduction of High Speed Rail	1
2 History of HSR	2
3 Safety Issues and Solutions	3
4 Motivation	4
5 Contributions	5
6 Guide to the Thesis	6
II Background Knowledge	7
1 Real Collision Test	7
1.1 Test Process	7
1.2 Test Facility	8
2 RTPSA	10
2.1 Data Source	10
2.2 Coefficients Calculation Module	12
2.3 Coast-Down Simulation Module	14
2.4 Propulsion Simulation Module	16
2.5 Control/Release Module	17
2.6 Summary	18
3 PID Controller	19
3.1 Proportional Term	20
3.2 Integral Term	21
3.3 Derivative term	22
3.4 Tuning Coefficients	22
3.5 Summary	22
III Limitation of RTPSA	24
1 Early Safety Warning	24
2 Deviation of Simulated Release Point from Real Release Point	26

IV Improved RTPSA	29
1 Design Principles	29
1.1 Necessary Simulation Before Real Test	29
1.2 Feasibility of the Calculation Based on Simulated Data	32
2 Software Structure	33
3 Early Safety Warning Module	35
3.1 Principle and Design	35
3.2 Program Logic	44
4 PID Controller Module	46
4.1 Principle and Design	46
4.2 Program Logic	50
5 Summary	51
V Experiment Results	52
1 The Demonstration	52
2 Experimental Results of <i>LCA</i> and <i>LCR</i>	55
2.1 Different Crash Velocities	55
2.2 Different Barrier Locations	55
2.3 Different Safety Distance	56
3 Comparison of Different PID Configuration	57
3.1 Different Sets of Coefficients	57
3.2 Different Sampling Frequency	60
4 Results of the Improved RTPSA in Different Situations	61
4.1 Real Crash Velocity	61
4.2 Results of Different Crash Velocity	63
4.3 Result of Different Barrier location	64
4.4 Result of Different Safety Distance	65
VI Conclusion	66
REFERENCES	67
VITA AUCTORIS	72

LIST OF TABLES

1	The results of <i>LCA</i> and <i>LCR</i> based on different crash velocities. . . .	55
2	The results of <i>LCA</i> and <i>LCR</i> based on different barrier locations. . .	56
3	The results of <i>LCA</i> and <i>LCR</i> based on different safety distances. . .	56
4	The results of different PID coefficients. The unit of velocity is <i>kmph</i> .	58
5	The results based on different sampling frequency.	60
6	The results based on different crash velocities.	64
7	The results based on different barrier locations.	64
8	The results based on different safety distances.	65

LIST OF FIGURES

1	Three phases of the collision test.	8
2	Test facility one[18].	8
3	Test facility two[18].	9
4	Test facility three[18].	9
5	Data for simulation[18].	11
6	Coefficient module, from A to C[18].	13
7	Coast-down module, from B to D[18].	15
8	Propulsion module, from C to B[18].	17
9	Safety warning information, schematic diagram.	25
10	Deviation of simulated release point from real release point, schematic diagram.	27
11	The behaviour of the test train in improved RTPSA, schematic diagram.	28
12	Effect of proportional gain, schematic diagram[5].	30
13	Structure of original RTPSA[18].	33
14	Structure of improved RTPSA.	34
15	Parameters in <i>LCA</i> , schematic diagram.	36
16	Same image as Figure 15.	39
17	Parameters in the second part of early safety warning module, schematic diagram.	41
18	Uniform motion in original RTPSA, schematic diagram.	44
19	Flow chart of safety warning module.	45
20	The simulation model in Simulink, Matlab.	48
21	The structure of tuning module.	49
22	Parameters for PID module in simulink.	49
23	The structure of tuning module.	51

24	The demo of improved RTPSA.	53
25	Important information in improved RTPSA.	54
26	Response time and transient behaviour in the tuning module.	58
27	Performance of different combination of PID coefficients.	59
28	Performance of different sampling frequency.	61
29	Different between real test and simulation, schematic diagram.	63

CHAPTER I

Introduction

1 Introduction of High Speed Rail

The High Speed Rail(HSR) is a rail transport technology which provides significantly faster speed than the traditional rail transport. As the definition of the HSR is not rigid, the lines operating from 160 km/h to, even more that, 250 km/h can be regarded as HSR[4].

Japan is the first country opening the HSR system to the public in 1964, in other words,this HSR system is in operation for around 50 years and carries more than 9 billion people in total[17][28]. Nowadays, HSR is operating in more than twenty countries (including the UK, France, Germany, Belgium, Spain, Italy, Japan, China, Korea, and Taiwan), while other around 20 countries are developing and constructing it(such as Turkey, Qatar, Morocco, Russia, Poland,etc.)[6][18].

In terms of the benefits, HSR offers a convenient, comfortable, affordable and safety choice to travel without delays. Other than this, it relieves the congestion on local traffics while delivers punctual and fast service to the passengers. Further more, it is powered by electricity,which as a result significantly reduces the budget on oil purchase for countries. And it creates plenty of job opportunities constructing the new rails and producing the train components[7].

2 History of HSR

The development of the railway is the development of the speed. In 1829, George Stephenson created a locomotive reaching 50km/h which represented the high speed standard of the train at that time[8][15]. However, this record was broken by many other higher speed at the beginning of the 20th Century.

Although the speed is satisfying at that time, the development of other transport modes push the train producers to strengthen the performance of the existing trains. After a huge speed improvement in Europe, in 1964, Japan impressed the world by the operation of a fully new standard gauge line, the Tokaido Shinkansen[17]. It was designed to operate at 210 km/h, with broad loading gauge, electric motor units, Automatic Train Control (ATC), Centralised Traffic Control (CTC) and other modern improvements.

After the huge success of Japanese HSR, the European HSR was born in France between Paris and Lyons in 1981, at a maximum speed of 260 km/h[8]. In addition to its high speed, the compatibility with the original rail system was considered as the most important contribution, due to its influence on the future upgrade of the old railway system.

Based on the experience of HSR in France, many other European countries such as Germany(in 1988), Spain(in 1992), Belgium(in 1997), the United Kingdom(in 2003) developed their own high speed railway system[30]. At the same time, China built the HSR in 2003. Chinese HSR was operating at the average speed of 200kp/h or even higher[22].

A new step forward for HSR started in China on 1 August 2008, when the 120 km long high speed rail between Beijing to Tianjin was build[14]. After 2008, China implemented almost 20,000 kilometres of new high speed lines consisting of upgraded con-

ventional railways and newly built high-speed passenger designated lines (PDLs)[16]. The HSR system in China carries at least 800 million passengers per year (from 2014 and growing), more than half of the total high speed traffic in the world[3].

3 Safety Issues and Solutions

Because of the increasing speed of HSR, the safety issues turns out to be more important. On 23 July 2011, a deadly crash happened between two high-speed trains travelling through Wenzhou, China. Forty people were killed, and at least 192 were injured. Based on the official investigation, the accident was blamed for the faulty signal systems which failed to warn the second train that the first train was on the same rail[2].

Another serious HSR accident happened in Santiago, Spain, on 24 July 2013. The train derailed at high speed when turning around on a bend, killing 79 people while other 140 were injured. The reason was the train exceeded the speed limit(80 km/h) twice when passing the bend[1].

Many other HSR accidents have not been mentioned here, and due to these unexpected collisions, a large amount of researchers in the area of HSR focus on safety issues. Some of the research topics refer to minimizing the human body injury when train accident occurs.

Due to the danger of high speed train accident, many countries have developed safety guidelines for the train in the designing phase to improve crashworthiness[26][23][13][29]. In order to test these designs, the real train collision test is required. In a real train collision test, a test train is accelerated by a propulsion system. After reaching a certain speed, it will be released and hit the barrier with a desired speed to observe the crashworthiness. Obviously, the test facilities require massive expense. As a result, simulation methods are introduced. There are lots of proposed simulation methods

which simulate the entire collision test based on theoretical data[21][20][19].

However, the existing simulation methods process only with the theoretical data and past experience, which can not completely study the behaviour of the test train in real test[24][27]. Thus, a recent method called Real Time Predictive Speed Analysis(RTPSA) will be discussed in this thesis. Different from previous simulation methods, RTPSA is a real time method implemented in a real collision test. RTPSA can analyse the effects of the factors which are difficult to be included by the traditional simulation methods as they are changing all the time and can not be predicted, such as the resistance of the air[18].

RTPSA firstly applies a regression analysis model to study the real time performance of the testing train, consisting of forces, velocity and location, which can be collected by the sensors. After some calculation, the relation between resistance and velocity is found and represented by an expression. Later on, this relation is used to predict the movement of the train, in order to find out the release velocity and location before the test train reaches this release point. And then, the test train can crash into the barrier with the desired velocity, if it is released at this release point. More details of RTPSA will be introduced in chapter 2.

4 Motivation

For study purpose, RTPSA is only implemented with simulated data. Although RTPSA operates as expected with simulated data set, there are still two important disadvantages.

The first disadvantage is lack of early safety warning for aborting the test. Exception may happen during the test and sometimes it is necessary to abort the test. Once the train is propelled by the propulsion cart, both the propulsion cart and the test train move extremely fast in a very short time. In order to abort the test safely

so that the test vehicle can brake successfully and the barrier is not damaged, the current RTPSA method has to be augmented with a module that can decide if aborting the test is doable by given the velocity of the train, and the distance travelled so far.

Another disadvantage is the difference between the predicted release point obtained by RTPSA and the real release point. This difference is caused by the insufficient simulated method utilized by RTPSA when predicting the behaviour of the test train, which will be mentioned in detail in chapter 3. Due to this reason, the train can not be released precisely, therefore required to be improved. And the improved method will be simply mentioned in next section and discussed in detail in chapter 4.

5 Contributions

The thesis focuses on solving the two disadvantages mentioned in the previous section.

The first contribution is a new additional functionality providing last chances to abort the test with least money losses in two different conditions. One is before release, in other words, the test train is connected with the propulsion cart. In this scenario, the system will offer a solution for stopping the test train and propulsion cart safely before they strike the barrier. The other condition is the test train has already been released. Thus, it can not be prevented to hit the barrier, when only the propulsion cart can be protected. In other words, this condition decides when is the last chance to release, otherwise the propulsion cart is not safe.

The other contribution, which is also the primary one, is forcing the test train to do the uniform motion before release, in order to reduce the negative influence from inaccurate simulation. Depending on the original output from RTPSA (release

velocity and location) and the “last chance” information from previous contribution, the new release velocity is obtained and applied as the input of the PID method. PID method controls the velocity of the propulsion cart, forces it doing uniform motion with the new release velocity until the test train disconnects with the propulsion system. More details of the PID method and the system’s design will be introduced in chapter 2 and 4.

6 Guide to the Thesis

This thesis is organized as following.

In chapter 2, the background knowledge underlying the proposed method will be reviewed. The chapter 3 presents the drawbacks of the current RTPSA. To solve these problems, the new method is introduced and broke down into details in chapter 4. And then, the comparisons and improvements can be observed from the running results in chapter 5. Finally, chapter 6 brings the conclusion of the new method.

CHAPTER II

Background Knowledge

This chapter reviews the background knowledge of the proposed method in this thesis. Typical setup in real collision test will be briefly reviewed. After that, the RTPSA method will be broken down into five sections and introduced. And finally, the PID controller will be discussed.

1 Real Collision Test

1.1 Test Process

Generally, the real collision test has three phases, which are propulsion phase, release phase, and coast-down phase. In Figure 1, from top to the bottom, the first subfigure describes the propulsion phase where the test train is propelled by a propulsion cart and accelerated from velocity zero. And when reaching the release velocity/location, the test train will be released immediately in the second subfigure - release phase. From this time on, in the third subfigure, the test train will be only affected by the resistance force, thus, coast down towards the barrier, and finally crash into it. In order to obtain a desired crash velocity, the release velocity/location is one of the most important factors to be controlled in this test, as the test train can hardly be controlled after release.

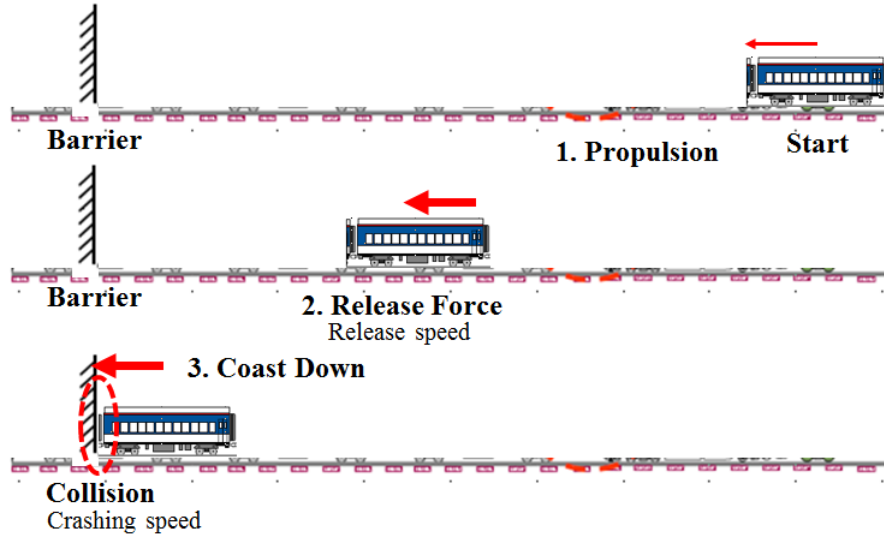

FIGURE 1: Three phases of the collision test.

1.2 Test Facility

The basic test facility is shown in the following images.

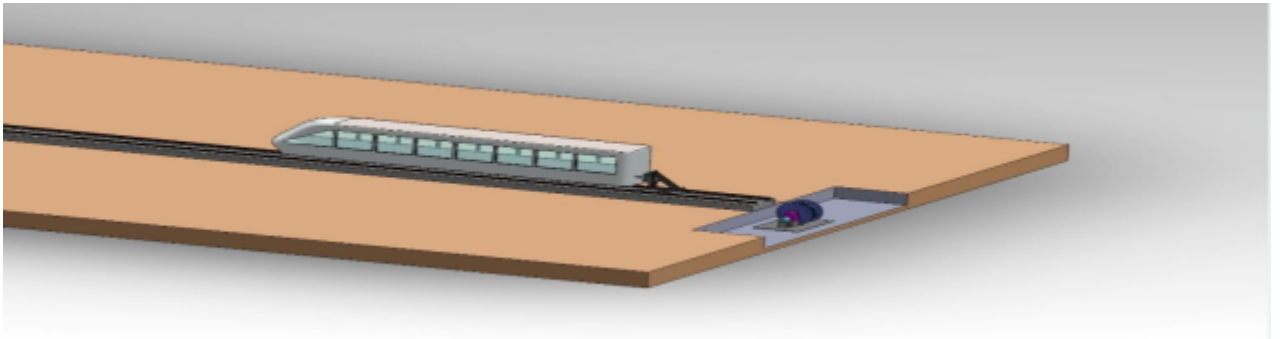

FIGURE 2: Test facility one[18].

In Figure 2, the test train is connected with the propulsion system, located on a straight guide rail and preparing to be accelerated.

In Figure 3, a rigid wall is located at the end of the rail. And in Figure 4, the building outside the rigid wall is a protection facility to prevent the damage of the collision.

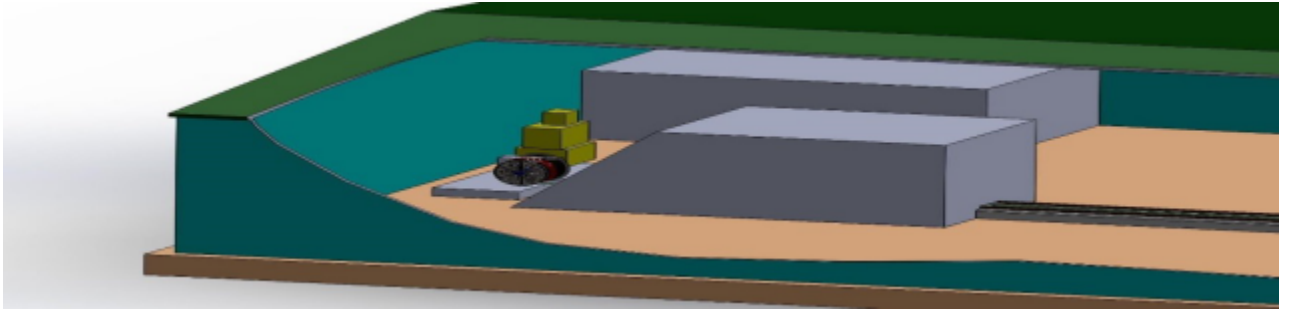

FIGURE 3: Test facility two[18].

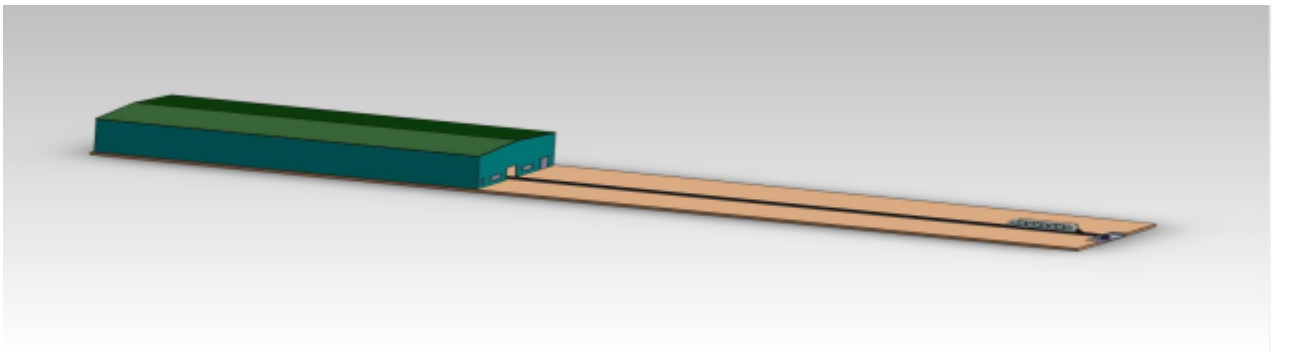

FIGURE 4: Test facility three[18].

2 RTPSA

The previous simulation methods are based on theoretical and historical data. However, in a real test, resistance forces vary all the time and are subjected to the velocity of test vehicle, wind speed and direction, temperature and humidity, which are different in every test. When the collision test is simulated by historical data or parameters, it brings about less accuracy of the release velocity and location, and inaccurate crash velocity as well, due to the unpredictable resistance forces. RTPSA (Real Time Predictive Speed Analysis) is a real-time method (can also process the simulation data) improving the previous ones, which can achieve a more accurate crash velocity by precisely controlling the release process. The advantage of RTPSA is that the most up-to-date calibration information can be derived from real-time propulsion behaviour during the real test[18].

The RTPSA consists of four modules.

- coefficients calculation module
- coast-down simulation module
- propulsion simulation module
- control/release module

At the beginning of the test, RTPSA will collect required data from sensors describing the behaviour of the test train. And then, the data will feed into coefficients calculation module for some calculations in order to predict the resistance. Based on the predicted resistance, the future behaviour of the train can be estimated, and the release velocity is calculated before the train reaches the release point. More details are in the following subsections.

2.1 Data Source

In an ideal condition, RTPSA should be implemented in a real test and collect real-time data. However, the simulated dataset is applied due to study propose and

high expense of a real test .

	A	D	E	F	G	H	I
8	v (kph)	F _a	F _m	R _a	A _a (m/s ²)	A _m	R _c = F _m -M x A _m
9	0						
10	0.72	99,900	99,525	450	6.629991	6.63190	46.30
11	1.44	99,800	99,881	450	6.623296	6.62347	528.68
12	2.16	99,700	100,000	451	6.616582	6.61838	724.55
13	2.88	99,600	99,593	452	6.60985	6.61186	415.30
14	3.6	99,500	99,151	453	6.603098	6.60560	67.27
15	4.32	99,399	98,632	454	6.596328	6.59679	- 319.96
16	5.04	99,299	98,828	456	6.589539	6.59222	- 54.88
17	5.76	99,199	99,778	458	6.582732	6.58477	1,006.07
18	6.48	99,098	98,328	460	6.575905	6.57866	- 352.39
19	7.2	98,998	98,385	462	6.56906	6.56840	- 140.63
20	7.92	98,898	99,295	465	6.562196	6.56395	835.93
21	8.64	98,797	98,918	467	6.555313	6.55266	628.44
22	9.36	98,697	97,958	470	6.548411	6.54901	- 277.20
23	10.08	98,596	98,803	474	6.541491	6.53923	714.42
24	10.8	98,496	98,178	477	6.534552	6.53148	205.96
25	11.52	98,395	99,096	481	6.527594	6.52895	1,161.78
26	12.24	98,294	98,700	485	6.520617	6.52171	874.08
27	12.96	98,194	97,816	489	6.513621	6.51521	88.22
28	13.68	98,093	98,798	494	6.506607	6.50956	1,155.03

FIGURE 5: Data for simulation[18].

Figure 5 shows part of the data used for simulation, which is given by Anemoi Technologies Inc. This dataset is applied in the design stage for studying and debugging purpose. It simulates the beginning propulsion phase by providing the information of velocity, force, and acceleration based on historical data, which will be measured by the sensors in a real collision test. At the meantime, the RTPSA is collecting all these data for the further calculation and simulation in order to predict the release velocity/location.

In the line “8” of Figure 5, there are three kinds of subscription, which are “a”, “m” and “c”, indicating three kinds of corresponding data - actual data, measured data and calculated data. Actual data simulates the real and theoretically performance of the system during the propulsion phase. However, due to the mechanical deviations of the hardware and sensors, the data appeared on the sensors will not be the actual data exactly, thus, is represented by the so-called measured data. Finally, the “calculated” data - “c” - is the one calculated from the measured data.

In addition, actual data will not be applied, as in real test the available data only comes from sensors, which is described by the measured data in this dataset. And later on, this dataset will be collected by RTPSA to predict the behaviour of the test train.

2.2 Coefficients Calculation Module

This module is a real-time calculating module, in other words, this module will continuously gather the data from sensors and do calculation while the test train is propelled. Although, in this research, simulation data replaces the real-time data, the data will still feed into the module in the same way as in a real test.

This module calculates the necessary coefficients which will be utilized in prediction of the future behaviour of the test train. As introduced previously, the changing resistance is the reason why most simulation methods can not work accurately. In principle, the resistance is the combination of two parts, which are friction and aerodynamic resistance. Based on the physics of friction and aerodynamic, the relation between R and v can be expressed by the following equation,

$$R = b_0v^2 + b_1v + b_2 \quad (1)$$

where b_0, b_1, b_2 are constants, $b_0v^2 + b_1v$ represents the aerodynamic force, b_2 corresponds to the friction. If given a set of data (R, v) , the three coefficients can be calculated, and then this relationship can be applied to predict the future behaviour of the train. The value of v is able to be collected from the sensors, so next question is how to obtain the corresponded resistance R . Actually, the whole behaviour of the train follows the laws of motion,

$$F - R = m * A \quad (2)$$

where F is the propulsion force given by the propulsion system, m is the mass measured by the sensors and A is the acceleration monitored by the sensors as well. Thus,

R is calculated and then combined with the corresponded velocity v measured at same moments. Thus, a dataset SET_{Rv} is gained,

$$SET_{Rv} : \{(R_t, v_t) : t = 1, 2, \dots, n\}$$

where R is resistance, v is velocity, and t is the timepoint when sensors do one measurement. With the knowledge of multiple linear regression model and dataset SET_{Rv} , the coefficients b_0, b_1, b_2 are obtained.

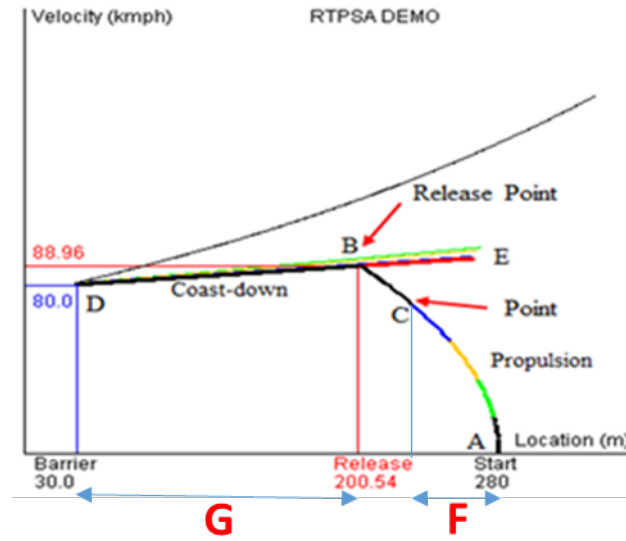

FIGURE 6: Coefficient module, from A to C[18].

In Figure 6, from point A to point C, the test train is accelerated from velocity zero, and in the same period RTPSA is collecting the data and calculating the coefficients following the ideas just introduced. Between point A and point C, there are intervals described by different colours. At the end of each interval, RTPSA will calculate the coefficients once, and evaluate the results based on the current collected data. By experiments, the first interval starting from point A, coloured by black, is proved unqualified for the further calculation, due to the instability of the data, while the combination of the other intervals are the most qualified[18]. Finally, before point C a set of coefficients (b_0, b_1, b_2) are obtained and waiting for the further utilization.

2.3 Coast-Down Simulation Module

The Coast-down simulation module is implemented right after the relation between resistance and velocity is obtained, contributing to accurately predict the behaviour of the test train during the coast-down phase.

Same as the propulsion phase, the coast-down behaviour also obeys the equation as following.

$$-R = m * A \quad (3)$$

where R is resistance, m is mass, and A is acceleration. The force F is disappeared, as there is no more force coming from the propulsion system. The resistance is the only influence on the train, which can be defined by equation (3). Since mass is predefined, the acceleration of the train after release is ready for further calculation.

Given the resistance changing with the velocity, the acceleration is also affected by the velocity. Further more, as the resistance is the only force, the acceleration will continuously decrease, so will the velocity. In other words, the coast-down phase is a variable acceleration motion. In order to study the relation between location and velocity, the whole process will be divided into small pieces and each piece is regarded as uniform acceleration motion, which is defined by the following expressions.

$$v = v_0 + At$$

$$S = S_0 + v_0t + \frac{1}{2}At^2$$

where v is the ending velocity of each piece, v_0 is the starting velocity of each piece, t is the time which divides the whole process and gives the size for each piece, A is the acceleration, and finally S_0 is the start location while S is the end location for each interval.

The acceleration is given by velocity, and the time is predefined. As each piece's end is connecting with the next one's head, if starting or ending velocity of any piece

is acquired, the whole process can be calculated based on this velocity. The coast-down behaviour starts from the moment when the test train is released and ends when the train crashes into the barrier. It is impossible to obtain the release information which is the result of RTPSA and will be gained at the very end. But the crash velocity/location is predefined, included the velocity and the location. Thus, instead of calculating forwardly, the calculation starts from the end point and processes backward to the start point, eventually gains a set of data SET_{BD} describing the coast-down motion,

$$SET_{BD} : \{(location_t, velocity_t) : t = 1, 2, \dots, n\}$$

where t is the time of each small piece of uniform acceleration motion.

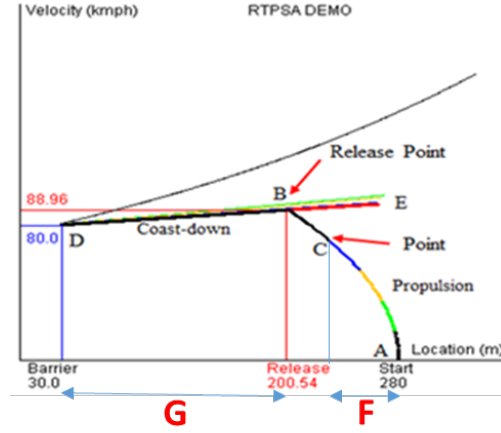

FIGURE 7: Coast-down module, from B to D[18].

In the Figure 7, the crash velocity is defined as 80 kmph, and the barrier is placed 30 meters away from the rail's end point. After the data collection and coefficients generation from point A to point C, RTPSA will immediately start to simulate the movement after release from B to D. Calculation proceeds from the point D, backwards to point B, and ends until a large enough size of dataset is obtained. After this module, the next mission is the prediction of the last propulsion phase described by segment BC.

2.4 Propulsion Simulation Module

The propulsion simulation module is invoked after the coast-down simulation module, and simulates the behaviour of the train after the data collection process and before release.

Theoretically, the test train is propelled from start point A to point B, but separated into two parts, the real running part AC and the predicted part CB simulated by RTPSA. The train is actually accelerated until enough data has been collected to obtain the coefficients(in the second module), after that, in order to predict the release point, RTPSA simulates the coming propulsion phase(last propulsion phase). The math model underlying the last propulsion phase is same as previous one when collecting data.

$$F - R = m * A$$

where the propulsion force F is controlled, mass m is constant, and resistance R can be retrieved by given the corresponded velocity based on the equation (1) from second module. Then acceleration is the only unknown parameter, and can be obtained. The last propulsion phase is variable acceleration motion, as acceleration is also changing on resistance which is varying on velocity. And it is continuous from the former propulsion phase, so the end point C of the collection process is the head of this phase. The velocity and location of point C can be measured, and by following the same idea in the previous module, the relation between the location and velocity is known. Finally, the last propulsion phase is predicted by a set of data SET_{CB} ,

$$SET_{CB} : \{(location_t, velocity_t) : t = 1, 2, \dots, n\}$$

where t is time of each piece of uniform acceleration motion.

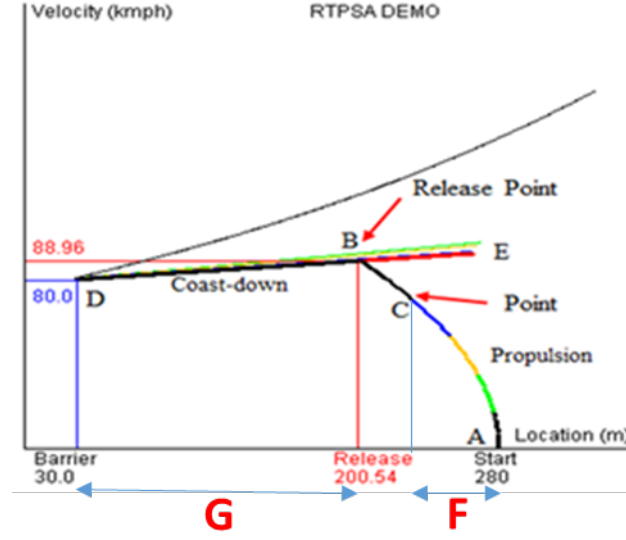

FIGURE 8: Propulsion module, from C to B[18].

Observing the Figure 8, the length of the curve CB is short, which indicates the time between release and the end of data collect does not last long. As introduced, during this period of time, the train is still accelerating and at meantime the calculation is proceeding. Thus, the actual time for the system to prepare for the release (which is called leading time) is defined by the following equation.

$$LeadingTime = T_{CB} - T_{calculation}$$

T_{CB} is the time that testing train spends in travelling from C to B. $T_{calculation}$ is the time for calculation by RTPSA. If the leading time is too small, the system can not complete the task. Usually, leading time should be 1 to 2 second, which decides the position of point C can not be too closed to point B, so generally the velocity of point C is given by the value of crash velocity[18].

2.5 Control/Release Module

After the coast-down simulation module and propulsion simulation module complete, the control/release module is implemented with the data sets from these two modules in order to obtain the final result - the release point.

For the purpose of seeking for the release point, the behaviour of the coast-down process and the propulsion process is required. Because the point of intersection between this two phases on the (location, velocity) coordinate system is the solution. However, these two phases are described by discrete data points, which results in the impossibility to find their intersection by simply search the same point in the two datasets. Even if there is one overlap point, the reason is just coincidence. In order to solve the problem, two approximated functions describe the data sets are required and the new goal is to find the intersection of these two functions. Thus simple linear regression model is qualified to discover the approximated functions, and then the release point will be obtained.

The reason why simple linear model is practical is from the observations on several times of experiments. First, by repeated experiments, the dataset SET_{BD} of coast-down phase is very closed to the fitted function of this phase calculated based on simple linear model[18]. Secondly, the time spent on the propulsion phase predicted by propulsion simulation module is very short, generally 1 to 2 seconds, leading to small error between the fitted function of propulsion phase and SET_{CB} [18]. Last, as the method will be deployed on real time test, the calculation time should be as short as possible and simple linear regression model can save time.

2.6 Summary

In RTPSA, the necessary data is collected during the first propulsion phase while the test train is propelled by the propulsion cart. After the software obtains sufficient data, it will invoke the coefficient calculation module to discover the relation between resistance and velocity. And this relation will be utilized in the prediction of the coast-down phase and the following propulsion phase by coast-down simulation module and propulsion simulation module. Therefore, their point of intersection is regarded as the expected release point where the test train will be released and hit the barrier with the desired crash velocity. As the entire calculation process operates in a extremely short time, the expected release point will be obtained before the test

train reach this velocity although the test is still in processing during the calculation.

3 PID Controller

PID controller is short for *proportional-integral-derivative* controller, which is a control loop feedback mechanism. PID controller aims to make a system keep stable at an expected status which is also named as setvalue/setpoint, such as controlling a car to keep a certain velocity. In order to achieve this goal, PID controller will monitor the status of the system frequently, and this frequency is called sampling frequency. After the sampling frequency is decided, at every time points, PID controller continuously generates outputs based on error values indicating the difference between a desired setpoint and a measured process value. And then, this output will be applied by the system in order to update its status. The measured process value is the feedback status of the system after the system applies the output from last time point[20].

The PID controller attempts to minimize this error value at next time point unless the difference equals to zero, and eventually, the system will maintain homeostasis at the setpoint. The error value occurring during the homeostasis is difficult to be erased, but can be controlled within a certain range.

Here is the expression for PID,

$$u(t) = K_p e(t) + K_i \int_0^t e(\tau) d\tau + K_d \frac{de(t)}{dt} \quad (4)$$

where K_p , K_i , and K_d are all non-negative values, representing the coefficients for the proportional, integral, and derivative terms which correspond to the three parts on the right side of the equal sign. They are significantly important for PID controller, which will affect the performance of the system, including stability and settling time. The settling time represents how much time the system spends in reaching the stable status.

The advantage of PID controller is it only relies on the measured process value, in other words, the underlying math model is not necessarily to be known[12]. Meanwhile, by tuning the three coefficients, the performance can be controlled within an acceptable range. But this method does not guarantee the best control[5].

3.1 Proportional Term

Proportional term is defined by the expression,

$$P = K_p e(t) \quad (5)$$

where K_p is a non-negative number, called *proportional gain*. And $e(t)$ is the error value on time t .

This term provides an output P which is proportional to the error value, by multiplying the error with a non-negative coefficient K_p .

The output P of this term is the principle part of the controller, while the other two terms plays an regulatory role. The value of the output should depend on the real requirements, not be too large or too small, which can be controlled by the proportional gain. An overly large gain cause a huge change in the output when the error is provided, and an over sensitive system[25]. On the other hand, if the gain value is too low, the system will become less sensitive even with a large input error[25]. Thus, for an ideal system, the output should be large enough to accelerate the pace to the setpoint when the error is high, and small enough when the error is low in order to avoid fluctuation.

However, sometimes the system can not be stable just at the setpoint. The error value between stable status and setpoint is named as steady-state error, generally resulting by a non-zero error requirement system, and the system is only driven by

proportional term[32][5]. The so-called non-zero error system is the one that continuously lose energy, such as a car with constant velocity. Because of the resistance, the velocity can not reach the one when the resistance is not existing. A part of the propulsion power from the engine will be spent to offset the resistance and then the car will lose a certain amount of speed. This amount losing speed is defined as steady-state error.

3.2 Integral Term

This term is given by the following expression.

$$I = K_i \int_0^t e(\tau) d\tau \quad (6)$$

where K_i is the non-negative number called integral gain, and $\int_0^t e(\tau) d\tau$ is the accumulation of the past error over time.

The output I of the integral term is related with both the magnitude and the duration of the error. It accumulates the instantaneous error over time, and such accumulation is just the sum of errors that should have been neutralized previously. Then, this sum is multiplied by the integral gain, indicating the relationship between the input error value and the output I , and added to the PID controller output $u(t)$.

The value of K_i should not be too large, otherwise will result in overshooting problem which means the status of the system will exceed the setpoint[9]. And a proper K_i can velocity up the movement of the system status towards setpoint and offset the steady state-error. As introduced in last section, the steady-state error is the loses of a system, which are collected, accumulated, then brought back to the system, and finally eliminated by the integral term.

3.3 Derivative term

Derivative term is defined by,

$$D = K_d \frac{de(t)}{dt} \quad (7)$$

where K_d is non-negative derivative gain. $\frac{de(t)}{dt}$ is the slope of the error over time.

This term estimates the trend of the system behaviour, and controls this trend to be stable by calculating the slope of the error, multiplying the derivative gain and then adding them to the PID controller output. It predicts the error for the next control loop and adds this future error in the current loop[10], which will decrease the error in the next loop, thus boost the settling time and stability[25][31]. Derivative term is rarely implemented in practice - by one estimate in only 25 percent deployed controllers, as its unstable impact on the stability of the real-world system[9].

3.4 Tuning Coefficients

As mentioned, the three coefficients significantly affect the performance of the system, as they describe the relationship between the input and the output. The contribution of the tuning process is the adjustment of the coefficients to an satisfying status for the expected system feedback, which not only brings about satisfying stability, but also desired settling time.

3.5 Summary

The PID controller will monitor and adjust the velocity of the uniform motion phase which will be appended to the existing RTPSA so as to obtain a more accurate release velocity. After the sampling frequency is determined, the setvalue of PID will be assigned by the desired velocity of uniform motion. The input is the difference between the velocity of the train at every time point and the setvalue. Then, the PID generates the outputs indicating the required force given by the propulsion system

at each time point in order to keep the test train doing uniform motion. The PID controller keep processing until the test train is released.

So far, the mechanism of the RTPSA and PID controller are introduced. And in the next chapter, the limitation of the current RTPSA will be discussed.

CHAPTER III

Limitation of RTPSA

In this chapter, the limitation of the current RTPSA is discussed in details. The limitations are the lack of early safety warning mechanism which indicates the last chance to abort the test and last chance to release the test train, and the deviation of the simulated release point from real release point.

1 Early Safety Warning

One limitation is lack of early safety warning mechanism. The early safety warning includes two situations. As exception may happen during the test and sometimes it is necessary to abort the test, in the first situation, once the train is propelled during the test by the propulsion cart, both the propulsion cart and the test train move extremely fast in a very short time. In order to abort the test safely so that the propulsion cart and the test train can brake successfully and the barrier stays safe, the current RTPSA has to be augmented with a module that can decide if aborting the test is possible given the velocity of the train, the distance travelled so far, and the brake distance of the propulsion cart and the train. The improved RTPSA method has to decide whether it is safe to abort the test when the propulsion cart is still attached to the train so that both can come to a complete stop before hitting the barrier. In other words, improved RTPSA should find out where is the last chance to abort the test (*LCA*). In the second situation, the test train reaches the calculated release velocity and then is released by the propulsion cart. The test train will coasts down to the barrier while the propulsion cart brakes immediately after release. In order to keep

the propulsion cart safely comes to a complete stop without hitting anything, the last chance to release the test train (*LCR*) should be decided by the improved RTPSA as well. During the test, there must be critical velocity/distance at which test has to be aborted or the test train need to be released before it is too late to make the decisions.

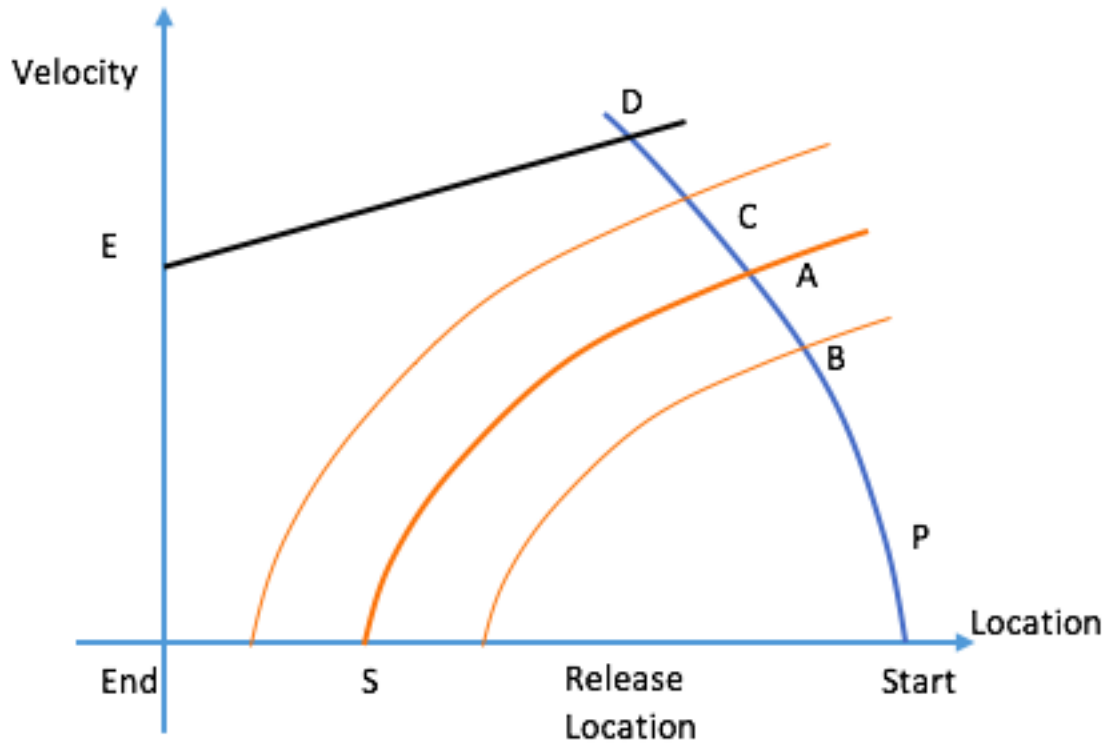

FIGURE 9: Safety warning information, schematic diagram.

For example, Figure 9 shows a location-velocity coordinate system. On this plane, the blue curve *P* represents the behaviour of the test train when it is propelled by the propulsion cart. The black line *DE* is the coast-down phase of the test train. The other three orange curves with similar shape describe the brake behaviour of the test train decelerated with the propulsion cart. The collision test starts at the *Start* point, and the barrier is located at the *End* point. Moreover, the safety distance is the distance between barrier and point *S*. The test train is propelled by the propulsion cart from the *Start* point. If the test is not aborted, when they reach the point *D*, the test train is released, then coasts down to point *E* and crashes into the barrier. If

the test needs to be aborted, after the brake phase, the test train and propulsion cart should finally stop between S and point $Start$ in order to be safe. Otherwise, they will be too close to the barrier and may not stop safely. Point A is the last chance to abort a test. If the test is aborted at this point, the test train and propulsion cart will just stop at point S . Thus, when the test is aborted before point A , such as point B , the test train and propulsion cart can stop safely. However, if point A is unknown and the test is still aborted at point C , the test train and the propulsion cart will not be safe.

2 Deviation of Simulated Release Point from Real Release Point

The RTPSA method could calculate precisely the release velocity and location in simulation. Once the release velocity is reached, the train is right away released in simulation. The simulation also demonstrates that the train will then hit the barrier at the exact desired crash velocity. This positive result proves in principle that the idea behind the RTPSA method works as expected, at least in simulation.

However, the inaccuracy occurs in simulating the last propulsion phase(mentioned in chapter 2) with simple linear model introduced in the control/release module of RTPSA. The motion of the test train in the last propulsion phase should be described by a curve on a velocity-location coordinate system. However, this motion is simply simulated by a straight line in the control/release module, which is an inaccurate simulation. This inaccuracy has influence on releasing precisely. Figure 10 shows the deviation of simulated release point from real release point. The X-axis is location, while Y-axis is velocity. The straight line $P1$ is part of the propulsion phase simulated by the control/release module. The curve $P2$ is part of the real propulsion phase corresponded to $P1$. Point C is the release point calculated by RTPSA, but this point is not on $P2$. Thus, if the train is released at the location of point C , the

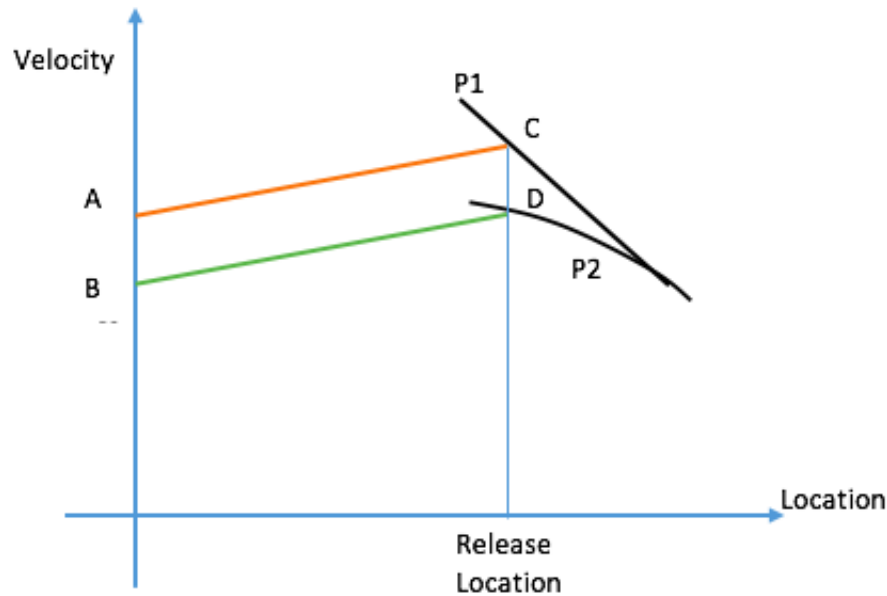

FIGURE 10: Deviation of simulated release point from real release point, schematic diagram.

real release point will be point D . As a result, the orange line AC represents the coast-down phase of the test train calculated by RTPSA, and the green line BD describes the coast-down phase in a real test. Point A is the required crash point, and point B is the real crash point. Obviously, there is deviation of real release point from calculated release point. This deviation will finally result in the inaccurate crash velocity.

However, if the train can maintain the release velocity for a short time before release (in other words, do uniform motion), it is easier to release the train and the deviation of real release point and calculated release point can be minimized. As shown in Figure 11, after accelerated by the propulsion cart, the test train will do uniform motion before release. After this motion, the test train will coast down and crash into the barrier with the desired velocity.

The disadvantages of the current RTPSA have already been discussed in this chap-

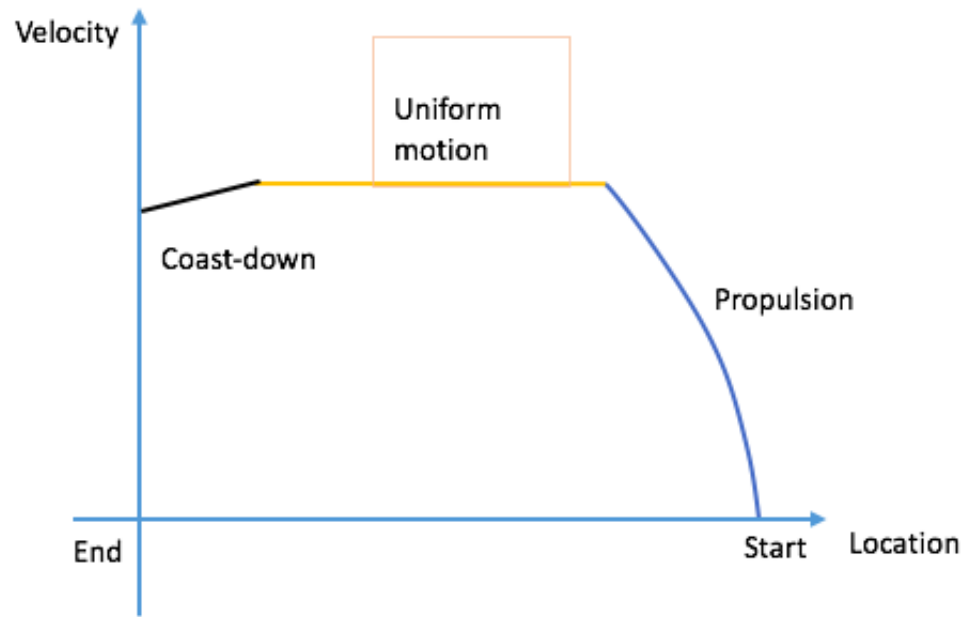

FIGURE 11: The behaviour of the test train in improved RTPSA, schematic diagram.

ter. And in the next chapter, the proposed method, improved RTPSA, is introduced to address these two limitations.

CHAPTER IV

Improved RTPSA

In order to solve the problem raised in the previous chapter, a new safety warning module is combined with the original RTPSA. Moreover, the test train will move with a uniform velocity before release, and the PID controller module is implemented to monitor and control this uniform motion phase in order to minimize the deviation between real release point and calculated release point. This chapter discusses the design principle, software structure and the details of these two new modules.

1 Design Principles

1.1 Necessary Simulation Before Real Test

Improved RTPSA will be deployed in real time collision test, where the test train will connect with the propulsion cart and be accelerated to a calculated release velocity, and then, instead of being released right away at this velocity, the train will move with this release velocity for a while and then disconnect with the propulsion cart at a calculated release location, in order to minimize the deviation of real release point from calculated(or called predicted) release point. Compared with the original RTPSA, there are two new modules, safety warning module and PID controller module, in improved RTPSA. In these two modules, there are some important parameters which consists of the outputs of early safety warning module and the coefficients of the PID controller. However, these important parameters are required to be decided in an additional simulation before the real test.

The outputs of early safety warning module is a set of early safety warning information. The early safety warning information includes two parts which are *LCA* and *LCR* mentioned in chapter 3. It may not be proper if the safety warning information is calculated during the real test. Assuming the train is running and RTPSA is calculating where is the release velocity/location and where is the last chance to abort the test. However, this last chance may have already been missed during the calculation before the result comes out. Then, even if the train is decelerated immediately, the test still can not be aborted safely. This kind of situation occurs when the length of the rail is too short or the propulsion force is too strong. To circumvent this circumstance, the safety warning information should be obtained in a simulation before the real test by studying simulated data.

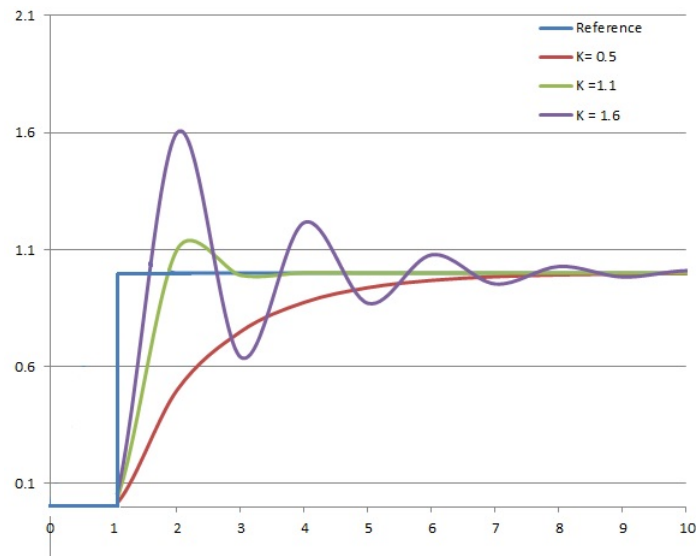

FIGURE 12: Effect of proportional gain, schematic diagram[5].

The PID controller will detect and adjust the velocity during the uniform motion. As introduced in chapter 2 section 3, there are three important coefficients K_P , K_I , K_D , affecting the performance of the PID controller system. In Figure 12, the X-axis represents the time, while Y-axis is the status of the object controlled by PID. The blue curve with two right angles indicates the ideal performance of the object. In this figure, PID controller will change the status of the object from 0 to 1.

The different K in the right-top corner represents the different value of proportional gain K_P , while K_I and K_D are fixed in this case. The performances of the object varying on different K is showed by different coloured curves. Moreover, the settling time is how much time the PID controller takes to adjust the object from one initial status to an stable status. And the stability represents how smooth the performance is. Obviously, in this figure, the stability and the settling time are significantly influenced by the proportional gain. Although this figure only shows the effect of K_P , the other two coefficients K_I and K_D also affect the performance of the controlled object. Moreover, these three coefficients are required to be tuned based on the performance of the controller, and can not be simply calculated by any expression. Different PID system may have different values of the coefficients to achieve expected performance, such as expected settling time and stability. Even for the same system but different setvalues, the best fitting coefficients might be different.

Generally, there are two ways to tune the coefficients. One is self-learning method[11] in which the system implemented with a machine learning method can adjust the coefficients of PID controller itself by studying the performance of the controlled system. This first way does not need human intervention and is normally used in the situation when the requirement of the system(setpoint) always changes or is not predefined. However, the machine learning process takes normally long time that cannot be tolerated in real time applications, thus is not selected in this project. In the second way, the three coefficients of PID are tuned by the people with their experience or software tools before PID controller is deployed. The drawback of the second way is it always requires a person to update the PID coefficients when the requirement varies. In this project the uniform motion velocity, which is also the setvalue of PID controller, is not predefined before RTPSA is deployed. But time is precious in a real time system, the first way is not proper in this project. As a result, the coefficients is tuned in a simulation before a real test by a software tool.

1.2 Feasibility of the Calculation Based on Simulated Data

As introduced, some parameters of the safety warning module and PID controller module is required to be calculated in a simulation test with simulated data. This subsection will discuss the feasibility of this calculation which is based on simulated data, in order to make sure if they are feasible in a real test.

The main drawback of the simulated data of a collision test is that the resistance force (all the resistance mentioned in below only consists friction and aerodynamic resistance) cannot be predicted precisely. Apart from the resistance, the other data (such as propulsion force, brake force and so on) of a real test can be simulated with very small deviation.

The purpose of the safety warning module is obtaining LCA and LCR (mentioned in chapter 3). The correctness of LCA and LCR is the most important requirement. If the test is aborted at or before LCA , the test train and the propulsion cart must definitely stop safely. However, as introduced, LCA and LCR are all calculated based on simulated data where the resistance can not be simulated precisely. If the inaccurate resistance is still considered, the correctness of LCA and LCR cannot be guaranteed. However, as a conservative strategy, if the resistance is not considered when calculating LCA and LCR , the test train must travel less distance in a real test where resistance exists, which can make sure the test train and propulsion cart stop within the safety distance. The feasibility and details of this strategy will be explained in the section “Early Safety Warning Module”.

In terms of the PID controller module, as introduced in chapter 2, it will control the system to be dynamically equilibrium at the setvalue. In other words, the status of the system will be controlled within a certain range, but not definitely just stay at the setvalue. As mentioned in chapter 2, PID coefficients K_p , K_i , and K_d will affect the status of the controlled system. As a result, generally, different sets of PID

coefficients can be found to satisfy a certain system, and at the same time one certain set of PID coefficients may be qualified in different systems, as long as the status of the systems are limited within an expected range. Thus, although the simulated data may be different from the real test data, the PID coefficients K_p , K_i , and K_d tuned in a simulation test can still be theoretically qualified in the corresponded real test. The experiment results is satisfied as well. However, more experiments, especially real test experiments, are still required in the future, since the current experiments are still based on simulated data introduced in chapter 2 section 2. Although this simulated data have already considered the deviation of real tests from simulations and try to eliminate this deviation with compensatory values[18], it is still a compromise to test the result of real data based on simulated data.

2 Software Structure

The original RTPSA is implemented and generates result as expected, however there are still limitations which are discussed in chapter 3. The improved RTPSA does not modify the original RTPSA but adding modules on it in order to obtain a better result. Improved RTPSA has three parts, early safety warning module, original RTPSA, and PID Controller Module.

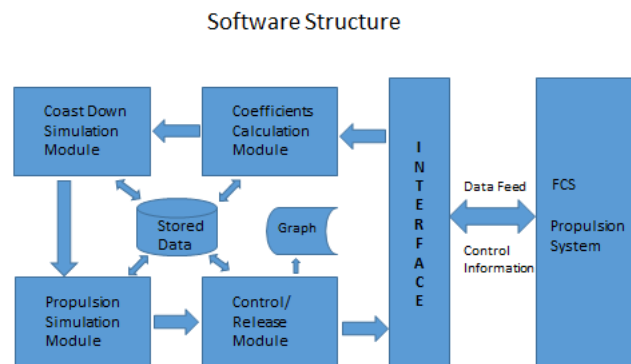

FIGURE 13: Structure of original RTPSA[18].

The structure of the existing RTPSA is shown in Figure 13. The input of original RTPSA is the data stream describing the propulsion phase, which comes from the

sensors in real test and is historical and theoretical data in simulation tests which is introduced in chapter 2 section 2. This data stream comes from the propulsion system on the right side of the figure, and then feeds into coefficients calculation module through the interface. The output coming from control/release module consists of two parts. One of them is the release point consisting of the release velocity and location. The other one is a demonstration video to demonstrate the whole test process. As shown in this figure, RTPSA collects the data stream of the propulsion phase from the hardware as the input of the coefficient calculation module. After calculation, a set of coefficients b_0, b_1, b_2 (mentioned in chapter 2) indicating the relation between resistance and velocity will be saved and passed to the coast-down simulation module as the input. Based on this relation, the resistance of the coast-down motion can be calculated and thus the whole performance of the coast-down phase can be predicted by SET_{BD} introduced in chapter 2. Then, the stored coefficients will feed into propulsion simulation module and another set of points SET_{CB} (introduced in chapter 2) are generated to predict the last propulsion phase before release. Eventually, this two sets of points will be treated as the input of the control/release module. The simple linear regression model is applied to build the math models of coast-down phase and propulsion phase. Then their intersection points is calculated and regarded as the output - release velocity/location. This information will be sent back to the hardware (FCS is short for facility control system) to physically release the test train.

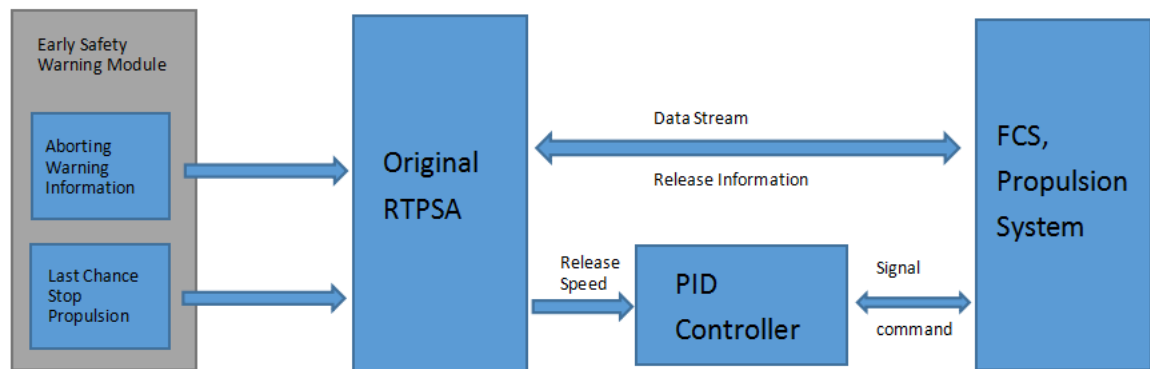

FIGURE 14: Structure of improved RTPSA.

In the improved RTPSA, two new modules, safety warning module and PID controller module, are augmented to the previous system as shown in Figure 14.

The early safety warning module is firstly implemented. In this module, the early safety warning information including LCA and LCR is calculated before a real test. Then, this information will feed into the original RTPSA.

After safety warning information is transferred, the original RTPSA will still operate in the almost same way as described in Figure 13. However, the only difference occurs in the last step - control/release module. The release velocity and location will be re-calculated. The details of the calculation will be discussed in the following sections. Then, the new release velocity is transferred to PID controller module as the setvalue to control the release process. When the test train reaches the release velocity, PID controller will communicate with propulsion system to force the test train to do uniform motion until it reaches the release location. After that, the test train will be disconnected from propulsion system, and then hit the barrier with the desired crash velocity.

3 Early Safety Warning Module

The early safety warning module focuses on two parts. The first part is the last chance to abort the test train(LCA), when test train connects with propulsion system. The second part is the last chance to release the test train(LCR) in order to keep the propulsion cart safe.

3.1 Principle and Design

In this module, LCA and LCR will be calculated. More specifically, LCA and LCR will be represented by two certain locations called safety locations. In other words, in terms of LCA , the test should be aborted before a safety location, and for LCR the propulsion cart should release the test train before another safety location as well.

In terms of *LCA*, the train is connected with propulsion cart. In this situation, firstly, the test train will be propelled by the propulsion cart to a safety location. This process is called propulsion stage. Then the test train and propulsion cart is decelerated to velocity zero and stops at or before the safety distance which is the last location for the test train and the propulsion cart to stop safely. This process is brake stage.

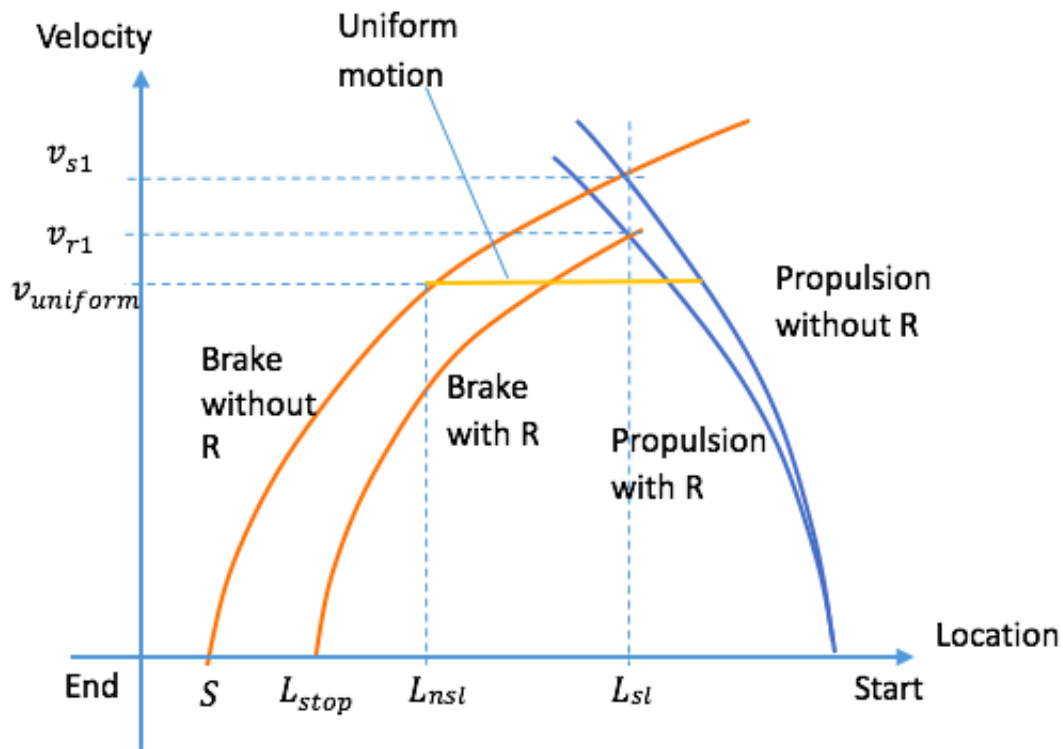

FIGURE 15: Parameters in *LCA*, schematic diagram.

As introduced, *LCA* will be calculated in a simulation before a real test is deployed. The resistance can not be simulated the same as the one in a real test. However the correctness of *LCA* remains the high priority. If the resistance can not be simulated accurately, the calculated *LCA* might not be correct. In other words, if the test is aborted at this *LCA*, the test train and the propulsion cart may not stop safely. Thus, as a conservative strategy, the resistance will not be considered when

calculating LCA (and LCR). The LCA calculated by this strategy may not be the best solution but will be completely correct.

Figure 15 shows the performance of the test train about LCA in a location-velocity coordinate system. The test train is propelled by the propulsion cart from the point $Start$, and the barrier is located at the point End . The distance between End and S is the safety distance introduced in chapter 3. The location of point $Start$ is zero. Assume that F_P is the propulsion force in both of simulation and real test, F_B is the brake force in both of simulation and real tests, m is the mass of propulsion cart and test train, R is the resistance force in real test. L_{sl} is the safety location of LCA calculated without resistance. If resistance is not in consideration, when the test is aborted at L_{sl} the test train and the propulsion cart will finally stop completely at point S just as shown in Figure 15. On the other hand, in a real test, if the test is aborted at L_{sl} as well, the test train and the propulsion cart will finally stop at location L_{stop} . Because of the influence of the resistance, L_{stop} must be smaller than S . As a result, the LCA calculated without R can guarantee the test train and propulsion cart stop safely.

So far, the correctness of L_{sl} is explained. In other words, if the test train and propulsion cart start to decelerate at or before L_{sl} , they will never reach S , thus can stop safely. Then the next goal is calculating where is L_{sl} .

As illustrated, the safety location L_{sl} should be calculated in the simulation without considering resistance. By observing Figure 15, L_{sl} is the intersection of the propulsion stage without R and the brake stage without R . The brake stage without R can be described by the following equation,

$$-F_B = m * a_{s2} \quad (1)$$

where a_{s2} is deceleration, $F_B > 0$. Thus a_{s2} is calculated,

$$a_{s2} = \frac{-F_B}{m} \quad (2)$$

And the relation between location and velocity is shown by the following equations,

$$L = L_0 + \frac{1}{2}a_{s2}t^2 \quad (3)$$

$$v = v_0 + a_{s2}t \quad (4)$$

where t is time, L is the location corresponded to the time, v_0 and L_0 are initial velocity and initial location, and v is velocity. As the brake stage without R goes through the point where velocity is 0 and location is S , then, if the brake stage is calculated backwards from this point, v_0 equals to 0 and L_0 equals S . By solving the equations (3) and (4), the relation between location and velocity can be calculated,

$$v = \sqrt{2(L - S)a_{s2}} \quad (5)$$

where a_{s2} is given by equation (2). Location S , mass and brake force F_B are provided before a test. Based on these information, the value of a_{s2} can be calculated.

In a similar way, the relation between location and velocity during the propulsion stage without R can also be calculated. The force of propulsion stage can be described by the following equation,

$$F_P = m * a_{s1} \quad (6)$$

where a_{s1} is the acceleration. As the propulsion stage without R goes through the *Start* point where location and velocity are both 0, the relation between v and L can be described,

$$v = \sqrt{2La_{s1}} \quad (7)$$

where the value of a_{s1} is obtained based on equation (6) and the information of mass and propulsion force are provided as well.

The location of the solution of equation (5) and equation (7) is the safety location L_{sl} . By solving these two equations,

$$L_{sl} = L = \frac{a_{s2} + S}{a_{s2} - a_{s1}} \quad (8)$$

where a_{s2} , S , and a_{s1} are known, thus L_{sl} can be calculated.

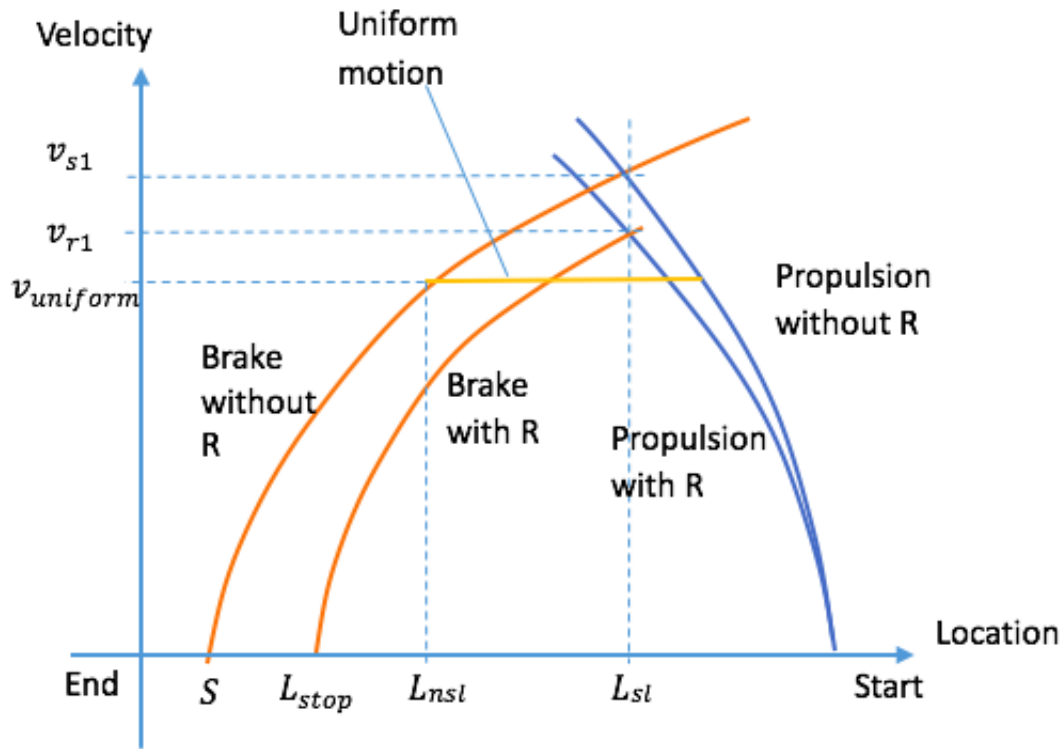

FIGURE 16: Same image as Figure 15.

So far, the calculation completes, if the train is propelled to a certain release velocity and is released without doing any uniform motion. However, if there is an uniform motion when the test train is propelled, the behaviour of the test train will differ from the one without uniform motion. In Figure 16, the yellow line represents the behaviour of uniform motion, where $v_{uniform}$ is the velocity of uniform motion. So the test train and propulsion cart will first move as described by the propulsion curve and then follow the uniform motion line, instead of moving on the propulsion curve throughout. In this situation, if v_{s1} is the corresponding velocity of L_{sl} while resistance is not considered, then $v_{s1} > v_{uniform}$. By observing Figure 16, when $v_{s1} > v_{uniform}$, the new safety location L_{nst} should come from the intersection of “the brake without R ” curve and the uniform motion line. Thus, the new safety location

L_{nsl} is calculated by solving the equations (5) where $v = v_{uniform}$,

$$L_{nsl} = L = \frac{v_{uniform}^2}{2a_{s2}} + S$$

. Thus, when $v_{s1} < v_{uniform}$, the value of L_{sl} is the safety location for *LCA*. On the other hand, while $v_{s1} > v_{uniform}$, the safety location is L_{nsl} . However, without the knowledge of $v_{uniform}$, it is impossible to determine which one is the safety location. Thus, the next goal is determining the value of $v_{uniform}$.

In terms of *LCR*, the safety location L_{rsl} for release will be calculated. Together with the safety location, the corresponding velocity v_{rsv} is also calculated. If the propulsion cart releases the test train at or greater than v_{rsv} and decelerates immediately, the propulsion cart can stop safely. In improved RTPSA, as the test train will do uniform motion before being released, the release velocity just equals to the velocity of uniform motion. Thus, the velocity of uniform motion $v_{uniform}$ must equal to or be greater than the safety velocity v_{rsv} . The goal of *LCR* is determining a proper velocity for the uniform motion in order to keep the propulsion cart safe after release.

The configurations of the test in Figure 17 are same as Figure 15. But in this figure, the test train will first be propelled to the velocity $v_{uniform}$, and do uniform motion with this velocity. The test train will be released at location L_{rsl} , and coast down to the barrier. Meanwhile, the propulsion cart (short for PC cart) will immediately decelerate after release. Moreover, the location of point *Start* is zero as well in this figure.

The propulsion cart must completely stop just at or before location S in order to be safe. And the safety location L_{rsl} is the last chance to release, and the corresponding safety release velocity is v_{rsl} . This location L_{rsl} is calculated without considering the resistance, then if the propulsion cart releases the test train at L_{rsl} , it will just stop at S in the situation without the resistance. Moreover, the location L_{rstop} represents the final stop location of propulsion cart in real test when the test train is

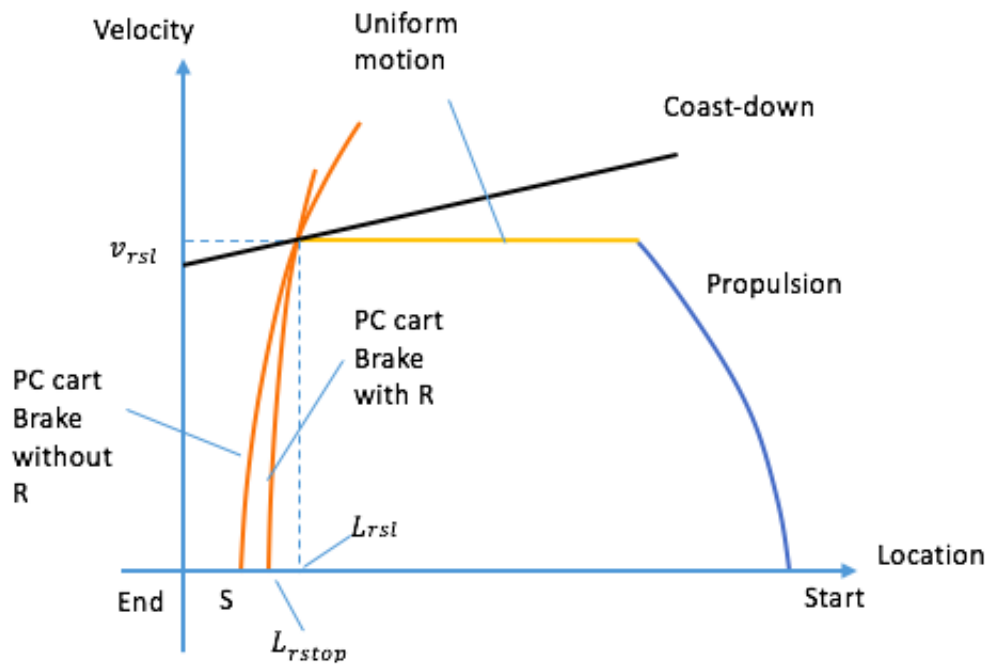

FIGURE 17: Parameters in the second part of early safety warning module, schematic diagram.

release at L_{rsl} .

As $v_{uniform}$ will not be affected by the resistance and $v_{uniform}$ equals to v_{rsl} when calculating LCR , L_{rsl} and v_{rsl} will be same in both of the real test and the situation without resistance. In other words, in both situations, the propulsion cart will release the test train at the same location and velocity. Because of the resistance, the inequality $L_{rstop} < S$ is gained. In other words, although L_{rsl} is obtained without considering the resistance, if the test train is released at v_{rsl} in a real test, the propulsion cart can still stop safely. Then, next goal is to calculate the value of v_{rsv} and L_{rsl} .

The brake stage of propulsion cart for LCR starts from the time when test train is just released, and ends at the time when the propulsion cart completely stops. The relation between location L and velocity v of the brake stage of propulsion cart can be described by the following equation,

$$v = \sqrt{2(L - S)a_r} \quad (9)$$

where a_r is the deceleration of the propulsion cart, and can be defined by the following equation,

$$a_r = \frac{-F_B}{m_{pc}}$$

where F_B is the brake force, and m_{pc} is the mass of the propulsion cart. And all these information can be obtained before simulation.

In improved RTPSA, the release location/velocity is the intersection of uniform motion and coast-down motion. The safety location of LCR - the last chance to release the propulsion cart - is also one of the possible release locations. Thus, location L_{rsl} and velocity v_{rsv} must be on the coast-down phase. In other words, this location and velocity is the intersection of the brake stage of propulsion cart and coast-down phase. In order to obtain the coast-down phase, RTPSA is required to be applied once based on the simulated data as introduced in chapter two section two. And

then, the coast-down phase is calculated and described by the following equation,

$$v = aL + b \quad (10)$$

where coefficients a and b are calculated by RTPSA. By solving the equations (9) and (10), the values of L_{rsl} and v_{rsv} are obtained.

As shown in Figure 17, the brake stage of the propulsion cart is almost vertical to the location-axis, reflecting that the brake time of the propulsion cart is short, since the mass of propulsion cart is small while the brake force is huge. Apart from extreme cases(such as the rail is too short or the crash velocity is too large), the propulsion cart is generally safe in the original RTPSA where the uniform motion is excluded, because the time for the coast-down phase is way greater than the time for the brake stage of propulsion cart. However, after uniform motion is included, the time of the coast-down process is critically cut down. As shown in Figure 18, assuming segment HI indicates the uniform motion, the test train will be detached at point I instead of the original release point B , which leads to the significant reduction of the coast-down phase, from BD to ID . If point J represents the intersection of the brake stage of propulsion cart and coast-down phase, the propulsion cart is dangerous after release when the velocity of point I is smaller than the velocity of point J . In order to avoid this situation, the velocity for the uniform motion $v_{uniform}$ should be greater than the velocity of point J which is the safety velocity v_{rsv} . And $v_{uniform}$ should also be smaller than the velocity of point B . As a result, the velocity of the uniform motion is calculated as following,

$$v_{uniform} = \left\lfloor \frac{v_{rsv} + v_{orv}}{2} \right\rfloor$$

where v_{orv} is the original release velocity calculated by RTPSA which is also the velocity of point B .

Moreover, the uniform motion velocity is also the release velocity. And the release velocity and location must be on the coast-down phase. In a real test, improved RTPSA will describe the coast-down phase with an equation same as equation (10)

but with different value of a and b . By solving this equation with the value of $v_{uniform}$, the new release location is obtained.

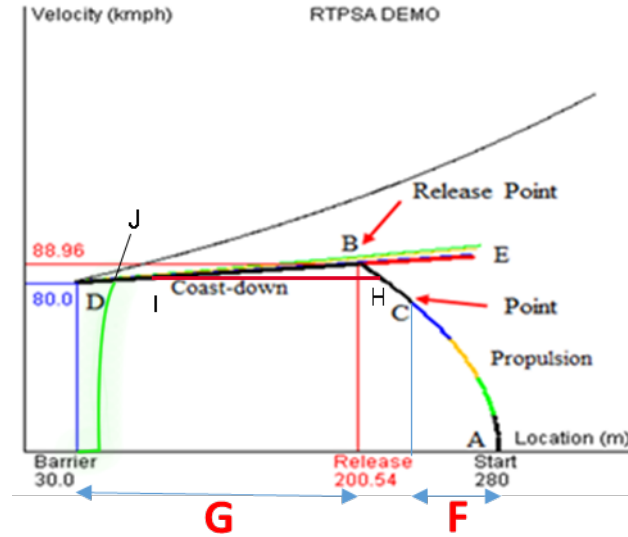

FIGURE 18: Uniform motion in original RTPSA, schematic diagram.

3.2 Program Logic

In Figure 19, the flow chart for the early safety warning module describes the program logic in the improved RTPSA.

First, the data stream, consisting of the mass, force, safety distance and other basic information, is transferred to this module. And then, the math models indicating each phase of motion are built. One of them, the model for brake stage of propulsion cart is prepared to feed into RTPSA for simulation. In terms of other two models, the propulsion phase for the test cart and the propulsion cart and the brake process of these two objects, the location of their intersection will be regarded as the initial version of the last chance to abort a test. Both of this safety location and the math model of the brake phase for the two objects will be collected by the RTPSA as well. Then RTPSA will determine the new release velocity based on the brake phase math

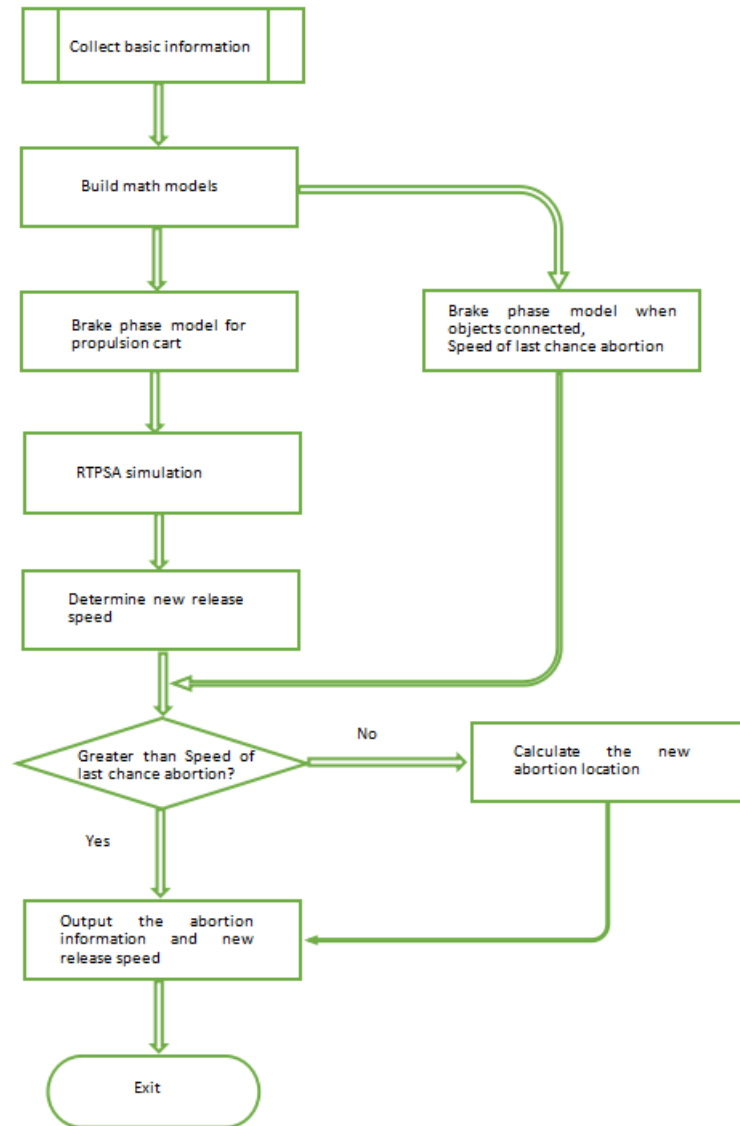

FIGURE 19: Flow chart of safety warning module.

model of propulsion cart. If the new release velocity is greater than the velocity of initial version last aborting point, the outputs of early safety warning module will be the new release velocity and the initial version last aborting location. If not, the new safety location for aborting the test will be gained from the intersection of the brake stage of propulsion cart and the uniform motion phase. This location together with the new release velocity will be the outputs.

4 PID Controller Module

The test train will move with a uniform velocity for a while before disconnecting from propulsion cart, in order to obtain a better release velocity. The uniform motion is controlled by PID controller module which is separated from the main components of RTPSA but directly communicates with hardware. The RTPSA provides PID controller the required velocity for uniform motion. And then PID controller monitors and adjusts the velocity of the test train, in order to make the test train to do the uniform motion with desired velocity.

4.1 Principle and Design

As introduced in chapter two, PID controller is short for *proportional-integral-derivative* controller, which is a control loop feedback mechanism. It generally consists of three terms, and in each term there is a corresponding coefficient which indicates the relation between the feedback of the system affected by the output from the previous time point and the required output of the PID which will change the status of the system at this time point. The length of the time interval between neighbouring time points is the sampling frequency. Together with the PID coefficients, they are the top two important factors affect the performance of the PID controller. Based on these two factors, the PID method will control the system to reach the predefined status - setvalue, and be stable at this status.

In the improved RTPSA, as mentioned in early safety warning section, the new

release velocity is calculated, which is also the velocity of uniform motion and the setvalue of PID controller.

Then, the sampling frequency is assigned with different values, ranging from $0.05ms$ to $10ms$, so as to observe the behaviour.

In terms of the coefficients, the tuning process can generally be completed in two ways. One is self-learning method[11] in which the system binding with the machine learning method can adjust the coefficients itself by studying the characteristic of system status when PID controller is operating. This method does not need human intervention, however, the machine learning process spends a lot of time on studying, thus is not expected in this project. The second method is tuned by people with their experience or software tools, but it costs less time when PID controller is working. In this project, time is precious, so the coefficients are tuned in the simulation situation by a professional tool - Simulink in Matlab.

The PID controller has two parts, which are the PID module controlling the velocity of the test train and the tuning section in Matlab to adjust the coefficients.

In the first part, the kernel function of PID is programmed, while the three coefficients are waiting to be assigned by proper values from the tuning section. This module connects with the programming interface of the propulsion system and the sensors, so as to timely monitor the status of the test train and adjust its velocity.

In the tuning section, a model is built to simulate the behaviour of the train within the uniform motion. The structure of the model in Simulink is shown in Figure 20. The input of this system is either the propulsion or brake force from the propulsion system, while the output is the velocity of the test train. As introduced in chapter two, the equation underlying the behaviour of the train can be defined by

$$F - R = m * A \quad (11)$$

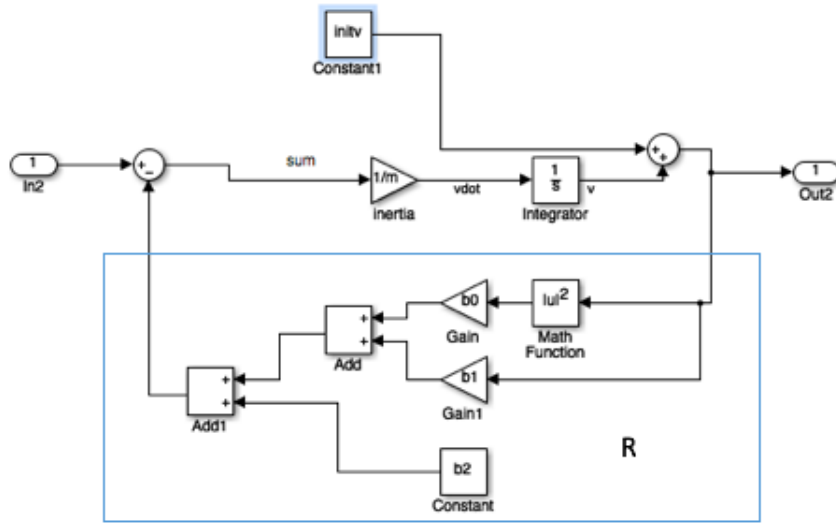

FIGURE 20: The simulation model in Simulink, Matlab.

while the R is described by

$$R = b_0v^2 + b_1v + b_2 \tag{12}$$

where F is the force from propulsion system, R is the resistance, m is the mass, A is acceleration, v is the velocity and b_0, b_1, b_2 are the coefficients indicating the relation between velocity and resistance. The expressions explain why the input minus a certain value on the right-top corner in Figure 20. The progress R in the bottom part of the figure calculates the resistance based on velocity, and the velocity is coming from the top part and the three coefficients will be gained from RTPSA. After $F - R$, the current value will be divided by mass in order to calculate the acceleration. And then the velocity is obtained by integrating the acceleration, which will be used to calculate the resistance and also as the output of this system. Moreover, the constant named as $Initv$ is the initial velocity, since this system aims to describe the uniform motion in the collision test where the initial velocity of PID controlled phase is not zero. So far, the behaviour of the test train is simulated and ready to combined with PID model.

The Figure 21 shows the entire process of the tuning section. The input is the

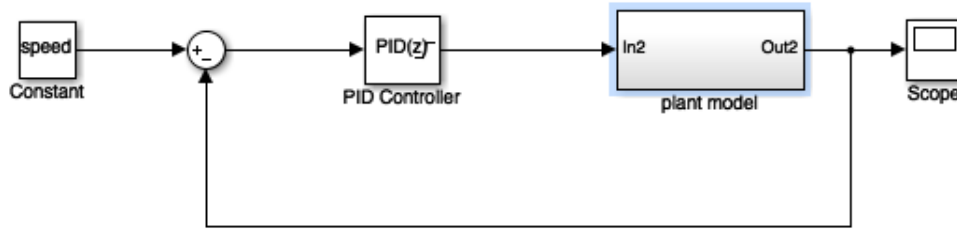

FIGURE 21: The structure of tuning module.

setvalue of the PID controller, which is also the expected velocity for uniform motion. And then it will minus the output of the plant model, which is the capsulation of the previous simulation model, representing the current status of the object(test train). Their difference will be the input of the PID controller. After the processing by PID, the difference of the velocity will transformed to the required force in order to keep the objects moving with the desired velocity. This force will feed into the plant model to generate an updated status. The entire operations will keep repeating until the test train is released.

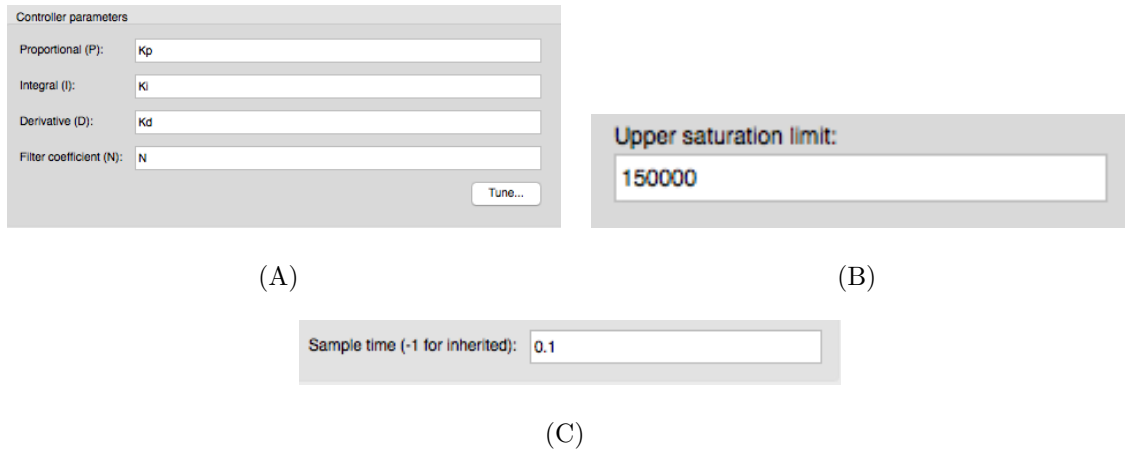

FIGURE 22: Parameters for PID module in simulink.

In this project, the PID module is already given by the Simulink, even includes the coefficients tuning functionality which can significantly simplify the tuning process. Figure 22 shows the configuration of the PID module, where the three coefficients are defined as variables in order to be adjusted by the software when clicking the tune

button in the right bottom corner in image (A). The upper saturation limit indicates the maximum force given by the propulsion system. And the sample time will be assigned by different values so as to discover which is the best. In Simulink the tuning process is quite simple as all the calculation is taken care by the tool, while the user is just required to adjust the settling time and robustness.

After the coefficients are tuned, they will feed into the PID controller modul, to control the velocity of test train.

4.2 Program Logic

The Figure 23 indicates the program logic of this module. First of all, the release velocity and the coefficients representing the relation between velocity and resistance will be provided by the RTPSA implemented with the simulation data in the early safety warning module. The coefficients will be utilized to build the simulation model in Simulink where this model will simulate the performance of the test train by given the force calculated by PID module in Simulink. In a real collision test, this performance will be collected by the sensors, and the calculated force will be transferred from PID controller in the improved RTPSA to the propulsion system through the software interface.

And then, the coefficients of PID controller are adjusted by the Simulink based on the constructed system, and feeds into the PID module built for the real collision test. So far, the entire process of this module complete, and the improved RTPSA is prepared for a real collision test as well.

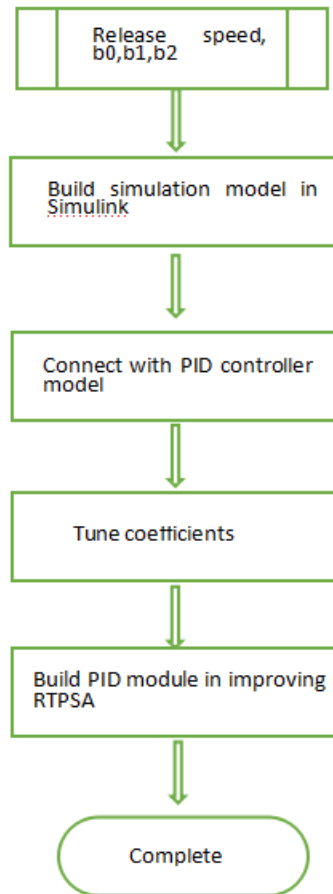

FIGURE 23: The structure of tuning module.

5 Summary

In this chapter, improved RTPSA explains how to improve the performance of the original RTPSA. The early safety warning module is operated to offer the information for safely aborting. Moreover, in order to obtain a more accurate crash velocity, the test train well maintain the release velocity for a while before disconnection. The PID controller module is appended to the existing software to fulfill this task. The details of these two modules are discussed after the explanation of the design principles.

In the next chapter, the running results will be introduced and analysed in different scenarios.

CHAPTER V

Experiment Results

In this chapter, the demonstration of the improved RTPSA and several experiment results are presented. The comparisons includes the results of *LCA* and *LCR* in different situations, the behaviour of PID controller with different sets of PID coefficients and different sampling frequency, the performance of the improved RTPSA in different situations, and the improvement against the original RTPSA.

1 The Demonstration

As shown in Figure 24, the demonstration module is developed to show the most important information and the entire behaviour of the system during collision test. In this screen shot, the performance of the system is presented in a location and velocity coordinate system, where the X-axis indicates the location and Y-axis is the velocity. The test train is propelled by the propulsion cart from the right. After release and coast-down phase, the train will hit on the barrier which is located at the end of the rail. The propulsion cart decelerates after disconnection and will finally stop in front of the safety distance in this case.

In Figure 24, the length of the rail is 280 *m*, the barrier is located at the end of the rail where the location is 0 *m*, the safety distance is 50 *m*, the mass of the test train is 15000 *kg*, the mass of the propulsion cart is 3872 *kg*, the desired crash velocity is 100 *kmph* (The unit of all the velocities in this chapter are *kmph* same as *km/h.*), and the propulsion force and brake force from propulsion cart are both 60000 *N*. These

configurations are also the default configurations in the following experiments unless specified.

In the original RTPSA, the program will collect data as long as the test train is accelerated. The equations on the right side of Figure 24 painted by different colours correspond to the different phases during the data collection process, and evaluate the quality of the collected data in order to find out the most accurate data that can describe the relation between resistance and velocity. The largest correlation coefficient R^2 coloured by red represents the most qualified data set in this case which is the combination of the dark green, yellow and blue phases. The black phase is excluded as the unexpected R^2 . Based on the collected data, the release point is calculated and the test train will be released after being accelerated to this point. After the coast-down phase, the train will finally hit on the barrier.

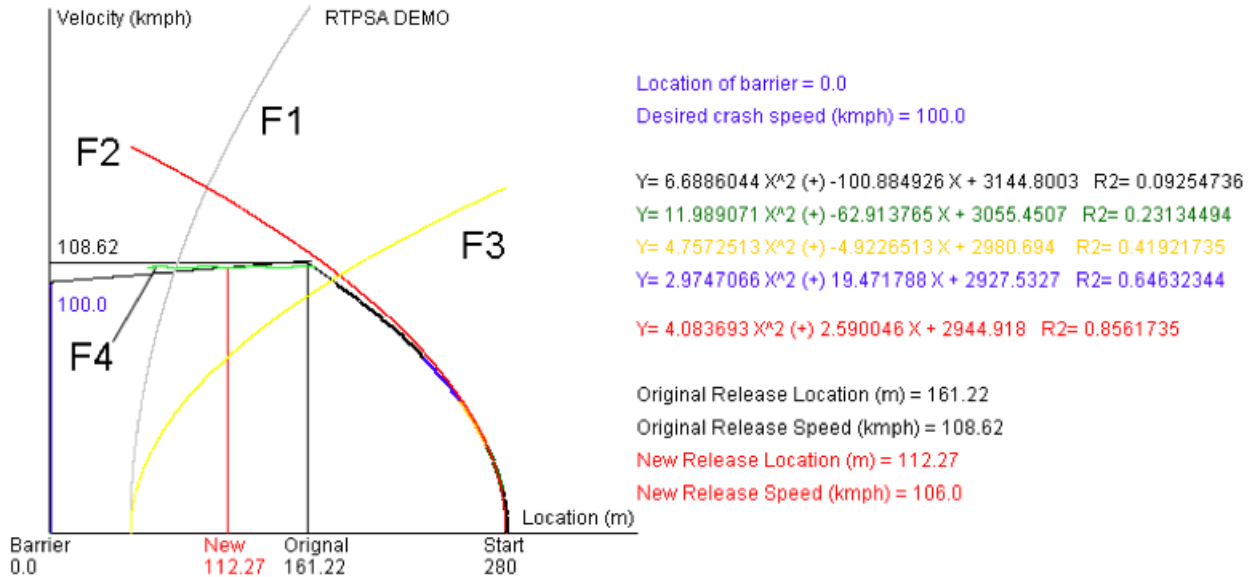

FIGURE 24: The demo of improved RTPSA.

In Figure 24, the curves F1, F2, F3 and F4 are four new elements in the improved RTPSA, comparing with the original RTPSA. F1 describes the behaviour of

the propulsion cart for *LCR*. Curve F2 is the model of the propulsion phase where the test train connects with propulsion cart. Because the resistance is not in consideration in this phase, *F2* is slightly different from the propulsion behaviour in real test which is on the left side and very closed to F2. F3 indicates the brake motion in terms of *LCA*. And F4 is the behaviour of the test train during the uniform motion phase.

In the improved RTPSA, the early safety warning is presented to the users at the very beginning of the collision test. As introduced in previous chapter, *LCA* is when the location of the train equals to the location of the intersection of F2 and F3.

After the collision test starts, the test train is still propelled by the propulsion cart, but instead of detaching at the release point generated by original RTPSA, the test train will attempt to move with a constant velocity(uniform motion) before release in order to obtain a more accurate crash velocity, which is described by F4 in this case. The intersection of F1 and the line of coast-down phase indicates *LCR*. And the velocity of uniform motion is defined by the average velocity of original release velocity and the last chance release velocity. The test train will move with this velocity following the green line F4, and be released at the point of intersection of F1 and coast-down phase.

All the important information mentioned in this section is calculated and presented by the improved RTPSA in Figure 25.

```

the location_of_barriar is 0.0 the speed of crashing is 100.0 the safety distance is 50
release location is 160.61887 release speed is 108.84535675048828
Last chance to abort when speed is:102.76296844482422kmph
Last chance to release when speed is:104.22008514404297kmph
The new release speed is:106kmph
The new release location is:109.20629m
The uniform motion starting location is:162.64993m

```

FIGURE 25: Important information in improved RTPSA.

2 Experimental Results of *LCA* and *LCR*

In this section, the program will be executed for several times to show the results of *LCA* and *LCR* based on different crash velocities and barrier locations.

2.1 Different Crash Velocities

In this subsection, all the configurations are same as the default one except the crash velocity. The results are shown in the following table.

Crash Velocity	<i>LCA</i> (location)	<i>LCR</i> (velocity)	<i>UMV</i>
60	178.15 m	63.99	69
70	178.15 m	73.1	77
80	178.15 m	83.6	87
90	178.15 m	93.9	96
100	178.15 m	104.13	106
110	178.15 m	114.5	116

TABLE 1: The results of *LCA* and *LCR* based on different crash velocities.

In this table, crash velocity ranges from 60 to 110. *LCA* is represented by location while *LCR* is described by velocity. *UMV* is short for uniform motion velocity which is affected by *LCR*. The unit of all the velocity is km/h(kmph). By observing this table, *LCA* does not change while crash velocity varies, as there is no relationship between crash velocity and *LCA*. Moreover, when crash velocity grows, *LCR* and *UMV* increase as well.

2.2 Different Barrier Locations

This subsection shows the influence of barrier location on *LCA* and *LCR*. The barrier location ranges from 5 to 25 while other configurations are same as default. The result is given by Table 2.

Barrier Location(m)	LCA(location)	LCR(velocity)	UMV
5	180.36 m	104.05	106
10	182.19 m	104.12	106
15	184.79 m	104.11	106
20	187.00 m	104.25	106
25	189.22 m	104.16	105

TABLE 2: The results of *LCA* and *LCR* based on different barrier locations.

Different from Table 1, *LCA* increases when barrier location raises. The reason is barrier location will affect the final location the test train and propulsion cart, and the final location has relationship with *LCA*. Moreover, the change of *LCR* and *UMV* is not obvious in this case.

2.3 Different Safety Distance

This subsection shows the effect of safety distance on *LCA* and *LCR*. The result is given by Table 3.

Safety Distance(m)	LCA(location)	LCR(velocity)	UMV
10	160.43 m	101.91	105
20	164.86 m	102.49	105
30	169.29 m	102.97	105
40	173.72 m	103.50	105
50	178.15 m	104.11	106

TABLE 3: The results of *LCA* and *LCR* based on different safety distances.

In Table 3, greater safety distance results in greater *LCA* and *LCR*, while *LCA* increases faster than *LCR*. Moreover, *UMV* does not change too much while barrier location raises.

3 Comparison of Different PID Configuration

As introduced previously, the uniform motion is controlled by PID controller, where the PID coefficients and sampling frequency has enormous influence on the performance. The following comparison demonstrates the effect of the PID coefficients and sampling frequency.

3.1 Different Sets of Coefficients

Before the real collision test, a simulation is required to determine a set of proper PID coefficients. In the simulation, the velocity of the uniform motion together with the relation between velocity and resistance are calculated and then feed into Simulink, in order to obtain the expected PID coefficients.

In the following experiments in this section, the barrier locates at 0 *m*, while the crash velocity is 100 *kmph*, the length of the rail equals to 280 *m*, safety distance is 50 *m*, and all the other parameters, such as mass and propulsion force, are same in each running result.

After the calculation of the RTPSA, the relation between resistance and velocity is presented by the following expression as an example.

$$Resistance = 5.5490303 * Velocity^2 - 47.64984 * Velocity + 3349.7234 \quad (1)$$

The velocity of uniform motion is calculated as 106 *kmph*, sampling frequency of PID controller is given by 0.1 *ms*. Based on these information, Simulink tunes the coefficients of PID and generates the next results.

P	I	D	RT	TB	Average	DS
783.4	52.33	-4088	28.34	0.6	106.02	0.12
14430	89.69	-15170	2.834	0.6	105.91	0.32
45660	986	-10020	0.817	0.6	106.01	0.07
61890	1852	-8765	0.59	0.6	106.01	0.13
55070	1529	-5707	0.59	0.7	106.02	0.12
157400	20960	3231	0.15	0.6	106.02	0.38
119600	15830	7239	0.15	0.7	106.01	0.38
78090	10220	11030	0.15	0.8	106.01	0.36
250200	2139000	912.9	0.06	0.6	106.02	3.17

TABLE 4: The results of different PID coefficients. The unit of velocity is *kmph*.

In Table 4, P, I, D indicates the three coefficients of PID controller. RT and TB are short for "response time" and "transient behaviour", which are two parameters affecting the performance of PID controller and can be simply tuned in Simulink. RT has influence on the settling time. In other words, when RT is small, the system will reach the setvalue in short time. TB indicates the robustness of the system, such as larger TB resulting in more smooth system. $Average$ is the average velocity of the uniform motion, and DS represents the standard deviation of the uniform motion velocity against the desired release velocity such as $106kmph$ in this case.

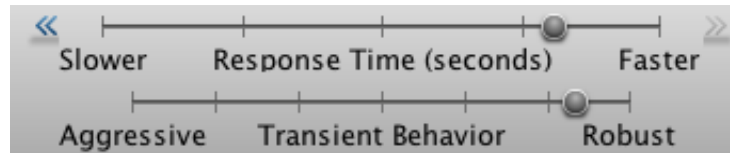

FIGURE 26: Response time and transient behaviour in the tuning module.

By observing Table 4, P and I significantly grow when RT decreases and TB does not change. There is no obvious rule on the alternation of D , but the positive value appears when the RT is too small. In terms of $Average$ and DS , the result is satisfying and does not change obviously when RT is greater than 0.59, but deterio-

rating if RT is less than 0.59. Comparing row 4 to 5 with row 6 to 8, the variation of TB has just slightly influence on the performance of uniform motion. However, larger RT still results in better performance.

Since the *Average* and *DS* can not completely show the influence of the coefficients, more clear results are presented in Figures 27. The green curve indicates the behaviour of the test train during uniform motion with different sets of PID coefficients. When $RT \geq 0.59$ in Table 4, the performance is satisfying and does not significantly differ from the situation in (A) where the curve is almost straight. As concluded in Table 4, when $RT \leq 0.15$ in (B), (C) and (D), the green curve appears to fluctuate and even shows extremely huge waves while $RT = 0.06$. Compared with (B), the green curve in (C) is smoother as given a greater TB , but amplitude does not reduce.

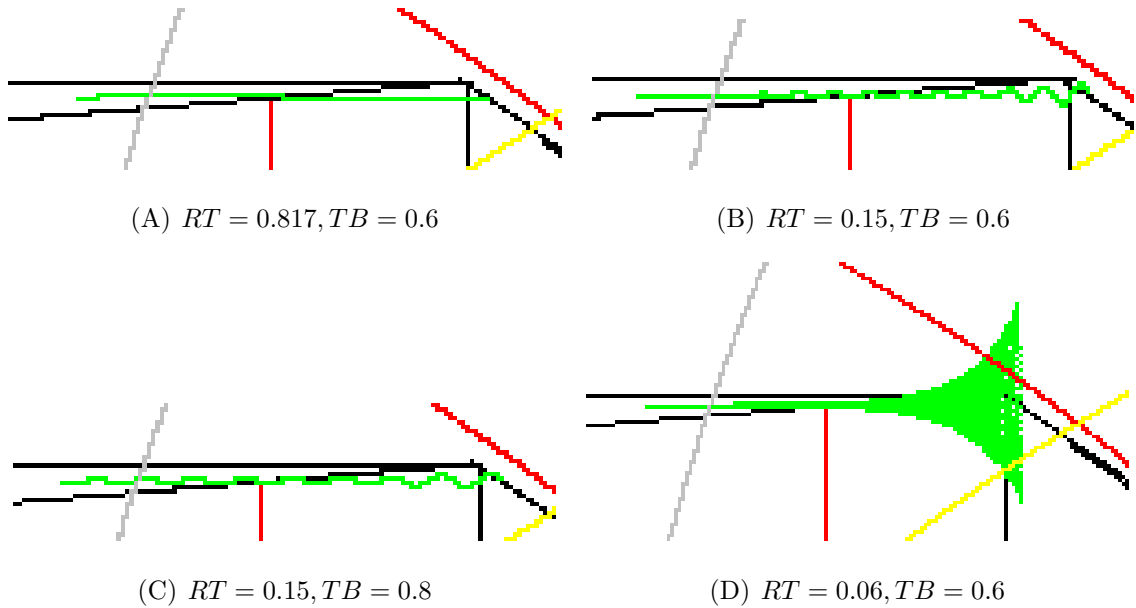

FIGURE 27: Performance of different combination of PID coefficients.

In conclusion, RT decides the stability of the train during the uniform motion, while a excessively small RT will results in a unstable system. Meantime, TB determines the robustness of the system. In this case, the expected result is generated

when $0.59 \leq RT \leq 28.34$ and $0.6 \leq TB \leq 1$.

3.2 Different Sampling Frequency

The sampling frequency is another important factor which determines the performance of PID controller, as it affects the response time against variation. A larger sampling frequency will bring about an insensitive system, while a smaller one will increase the cost of the hardware due to more operations will be done within the same time.

The following results shows the influence of the sampling frequency, in the condition where the release velocity equals to 106 kmph and the PID coefficients are given by row 3 in Table 4.

SF	Average	DS
10 ms(millisecond)	107.737	1.924
1 ms	106.109	0.279
0.5 ms	106.021	0.178
0.1 ms	106.009	0.076
0.05 ms	106.004	0.052

TABLE 5: The results based on different sampling frequency.

In Table 5, SF is short for sampling frequency, while *Average* and *DS* share the same meaning as them in Table 4. Obviously, in this table, the performance of the uniform motion improves when the value of sampling frequency decreases. Although the difference among row 2 to row 5 is not obvious, the *Average* and *DS* is completely worse than others when $SF = 10 \text{ ms}$. The same result is demonstrated by Figure 28, where the value of SF are 10 ms , 1 ms , and 0.05 ms respectively in subfigure (A), (B), and (C). In this figure, the green curve is almost straight in (B) and (C), although the one in (B) is smoother than (C). Compared with (B) and (C), the green curve in (A) immediately increases from the beginning and then slowly decreases to the

release point. In conclusion, the smaller sampling frequency leads to more expected performance, however the capability of the hardware should be considered.

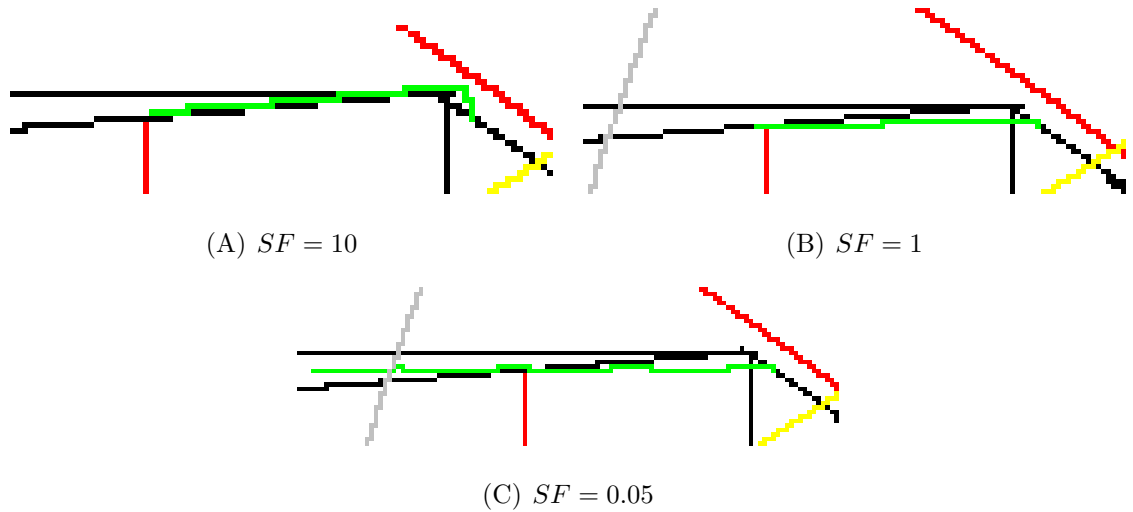

FIGURE 28: Performance of different sampling frequency.

4 Results of the Improved RTPSA in Different Situations

In this section, the results of the improved RTPSA in different situations will be presented and compared. More specifically, the different situations are different crash velocities, barrier locations, and safety distances. The result compares the performance of the test train in uniform motion phase and the real crash velocity with the original RTPSA. A more accurate crash velocity is the most important contribution of the improved RTPSA.

4.1 Real Crash Velocity

Based on experiment, the observation of the running result indicates that the inaccuracy of simple linear model simulating the last propulsion phase will reduce the accuracy of the original RTPSA. As a result, the real crash velocity is calculated in order to observe the deviation of real collision velocity from desired collision velocity.

This real crash velocity is not measured in real test, but calculated based on the simulated data. In other words, it is the simulated real crash velocity.

This inaccuracy will lead to the deviation of the real release point from the expected release point, and accordingly result in the error of the crash velocity. As introduced in previous chapter, the coast-down motion can be described by the next equation,

$$Velocity = a * Location + b \quad (2)$$

where a and b are coefficients. As shown in Figure 29(same as the one in chapter 3), the orange line AC indicates the coast-down phase simulated by simple linear regression model in original RTPSA, where the point A is the desired crash velocity. The point of intersection of line AC (coast-down phase) and the calculated propulsion phase's curve $P1$ is the release point predicted by original RTPSA. But because of the influence of the inaccurate simulation of the last propulsion phase mentioned in the first paragraph of this section, the real release point will be point D , and real coast-down phase is represented by the green line BD . Thus, the real crash point, B , will be the intersection of the velocity-axis and the green curve.

In the original RTPSA, the estimated real release point can be found from the dataset SET_{CB} (introduced in chapter 2 section 2.2) describing the propulsion phase based on the predicted release location of original RTPSA. For example, as shown in Figure 29, the predicted release point is C , if L is the location of C and V is the velocity of C . Then, the estimated real release point is the point (L, V') where V' is the corresponding velocity of L in SET_{CB} . By observing the results of experiments, the value of V' is different from the predicted release velocity V . Thus, the real release point is represented by (L, V') , and then the real crash velocity can be calculated. With the similar method, the real crash velocity of the improved RTPSA is appraised by operating with the dataset describing the uniform motion(collected by PID controller) instead of propulsion phase.

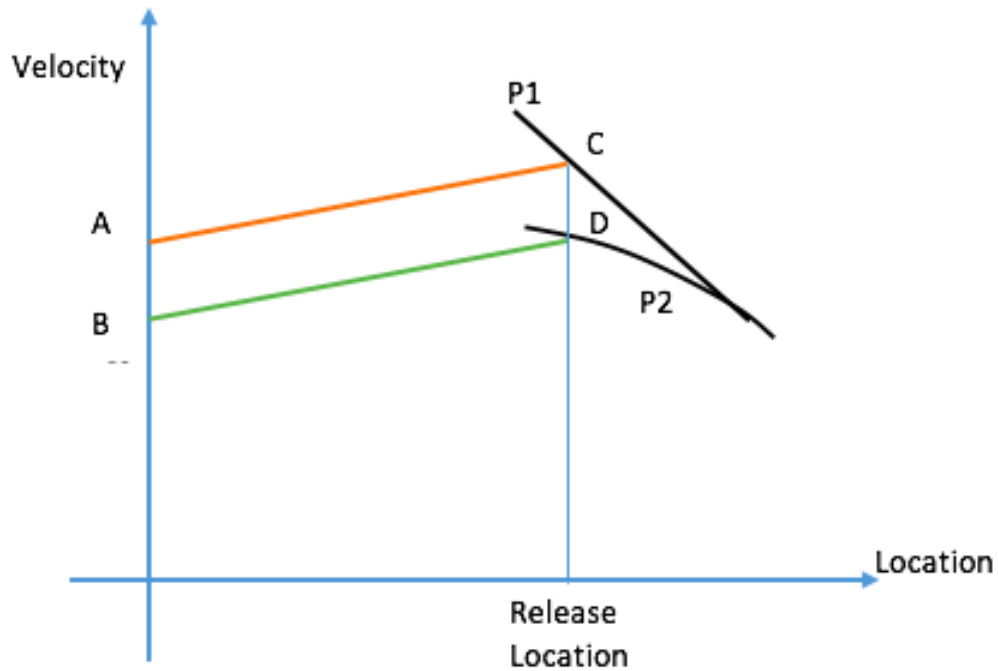

FIGURE 29: Different between real test and simulation, schematic diagram.

4.2 Results of Different Crash Velocity

In Table 6, the crash velocity varies from 60kmph to 100kmph , resulting in the change of the performance. In this table ORS is original release velocity, NRS is the new release velocity, Average and DS are the same meaning as in Table 4, ORCS is original real crash velocity and NRCS is short for new real crash velocity. All the configuration of PID controller utilized for different crash velocity are adjusted under same condition while RT is 0.6 and TB is 0.6 as well.

In this table, when the crash velocity is greater than 80kmph , the performance of PID is satisfying by observing the Average and DS. Furthermore, the real crash velocity of the improved RTPSA is way more accurate by reducing the error of the original RTPSA from around 2 kmph to the new error less than 0.1kmph . However, the interesting result appears when crash velocity is less than 70 kmph . The smaller crash velocity brings about worse performance of improved RTPSA, even worse than

the original one. The possible reason is when the crash velocity is small, the improved RTPSA does not have enough amount of data to obtain a proper set of coefficients to describe the relation between velocity and resistance. As a result, Simulink does not have sufficient knowledge to generate expected coefficients.

Crash velocity	ORS	NRS	Average	DS	ORCS	NRCS
60	72.6	68	68.012	0.089	58.72	57.67
70	80.7	77	77.012	1.06	68.7	68.258
80	91.4	87	87.015	0.11	77.87	80.009
90	99.3	96	96.01	0.12	88.017	89.945
100	108.6	106	106.01	0.12	97.88	99.870
110	117.5	116	116.017	0.13	107.569	109.912

TABLE 6: The results based on different crash velocities.

4.3 Result of Different Barrier location

In Table 7, the barrier location varies from 5 *m* to 25 *m*, resulting in the change of the performance. All the configurations of PID controller are the same as in 4.2.

Barrier Location(m)	ORS	NRS	Average	DS	ORCS	NRCS
5	108.62	106	106.02	0.12	97.46	99.54
10	107.92	105	106.02	1.08	97.14	100.22
15	108.08	106	106.02	0.12	96.75	99.30
20	107.70	105	106.02	1.07	96.38	99.70
25	107.51	105	106.02	1.08	96.01	99.79

TABLE 7: The results based on different barrier locations.

Table 7 shows that *ORS* and *NRS* do not change a lot, indicating that barrier location has slightly influence on the release velocity. *Average* and *DS* do not change obviously neither. Comparing *ORCS* and *NRCS*, *NRCS* is closer to the

desired crash velocity(100 kmph). In other words, the improved RTPSA has better performance as expected.

4.4 Result of Different Safety Distance

In Table 8, the barrier location ranges from 10 *m* to 50 *m*, while other configurations are the same as default. Moreover, all the configurations of PID controller are the same as in 4.2.

Safety Distance(m)	ORS	NRS	Average	DS	ORCS	NRCS
10	108.81	105	106.01	1.07	97.81	101.14
20	108.60	105	106.01	1.07	97.72	101.24
30	108.81	105	106.01	1.08	97.83	101.15
40	108.90	106	106.01	0.12	97.70	99.86
50	108.69	106	106.01	0.12	97.87	99.89

TABLE 8: The results based on different safety distances.

In Table 8, the change of safety distance almost has no effect on *ORS*. *NRS* does not change too much neither. The reason is safety distance just has slightly influence on *LCR*(result from Table 3), and *NRS* is calculated just based on *ORS* and *LCR*. Moreover, *NRCS* is still closer to 100 *kmph* than *ORCS*, just like the results in Table 6 and 7.

CHAPTER VI

Conclusion

There are two main improvements of the new version of RTPSA, which are the early safety warning for abortion, and a more accurate crash velocity.

The early safety warning module offers the information when is the last chance for aborting and releasing. As introduced in chapter 3, the knowledge of resistance is not required in this process, as a result, the safety warning could be given before the test. The demonstration can be observed in Figure 24 and the result is presented in Figure 25.

The second improvement gives the credit to the PID controller module. This module controls the test train to maintain a certain velocity for a short time before release, which reduces the deviation of the predicted release velocity from the real release velocity, and then provides a better accuracy for the crash velocity.

The stability of the uniform motion is influenced by the PID coefficients and the sampling frequency. In Table 4, the result indicates when RT (settling time of controlled system) equals to 0.6 or even larger than 0.6, and TB (robustness) is more than 0.6, the performance of the uniform motion phase is satisfying, otherwise it will be unstable. Table 5 shows that the smaller sampling frequency results in better performance of the controlled system. However, the smaller frequency implies the hardware will operate more times in the same period of time, thus increase the burden of the hardware. As a result, the performance and the capability should all be consid-

ered when selecting the sampling frequency. Given Table 6, the performance of the uniform motion is expected when crash velocity is greater than 80, but unsatisfying when crash velocity is less than 70. The possible reason for this undesired condition is the insufficient data collected to calculate the coefficients between resistance and velocity. Furthermore, by observing Table 6, 7, and 8, the improved RTPSA offers more accurate crash velocity than the original RTPSA in every case.

REFERENCES

- [1] More details about accident in Santiago Spain can be found on this website.
<https://en.wikipedia.org/wiki/SantiagodeComposteladerailment>.
- [2] More details about CBC News can be found on this website.
<http://www.cbc.ca/news/world/china-train-crash-that-killed-39-caused-by-signal-flaws-1.1083426>.
- [3] More details about Chinese high-speed can be found on this website.
<http://www.railjournal.com/index.php/high-speed/chinese-high-speed-an-evaluation-of-traffic.html>.
- [4] More details about definition HSR can be found on this website.
<http://www.uic.org/highspeedGeneral-definitions-of-highspeed>.
- [5] More details about PID can be found on this website.
<https://en.wikipedia.org/wiki/PIDcontroller>.
- [6] More details about the article Tracking Slower can be found on this website.
<http://www.economist.com/node/18898016>.
- [7] More details about the benefits for HSR can be found on this website.
<http://www.ushsr.com/benefits.html>.
- [8] More details about the benefits for HSR can be found on this website.
<http://www.uic.org/High-Speed-History>.
- [9] Ang, K. H., Chong, G., and Li, Y. (2005). PID control system analysis, design, and technology. *IEEE transactions on control systems technology*, 13(4):559–576.

REFERENCES

- [10] Araki, M. (2002). PID control. *Control systems, robotics and automation*, 2:1–23.
- [11] Åström, K. J., Hägglund, T., Hang, C. C., and Ho, W. K. (1993). Automatic tuning and adaptation for PID controllers—a survey. *Control Engineering Practice*, 1(4):699–714.
- [12] Bennett, S. (1993). *A history of control engineering, 1930-1955*. Number 47. IET.
- [13] Brickle, B. and Walker, R. (2003). Passenger train grade crossing impact tests: Test procedures, instrumentation, and data. Technical report.
- [14] Bullock, R. H., Salzberg, A., and Jin, Y. (2012). High-speed Rail—the First Three Years: Taking the Pulse of China’s Emerging Program. Technical report, World Bank.
- [15] Carlson, R. E. (1969). *The Liverpool & Manchester Railway Project, 1821-1831*. David & Charles.
- [16] Chen, X. and Zhang, M. (2010). High-speed rail project development processes in the United States and China. *Transportation Research Record: Journal of the Transportation Research Board*, (2159):9–17.
- [17] Feigenbaum, B. (2013). High-Speed Rail in Europe and Asia: Lessons for the United States. *Policy Study*, 418:46.
- [18] Jiang, X. J. (2015). Real Time Predictive Speed Analysis for High Speed Rail Collision Test.
- [19] Kim, S. R., Kwon, T. S., and Koo, J. S. (2008). Crashworthiness evaluation of the Korean high speed train using a virtual testing model. *International Journal of Modern Physics B*, 22(09n11):1383–1390.
- [20] Koo, J., Cho, H., Kim, D., and Youn, Y. (2001). An evaluation of crashworthiness for the full rake KHST using 1-d dynamic model. *Journal of Korea Society for Railway*, 4(3):94–101.

REFERENCES

- [21] Lee, H., Park, S., and Han, D. (1999). Crashworthiness Analysis of Korean High Speed Train Trailer. In *Fall Conference Proceedings of Korea Society for Railway*, pages 511–518.
- [22] Leung, C.-K. (1980). *China: Railway patterns and national goals*, volume 195. University of Chicago Committee on.
- [23] Mayville, R., Stringfellow, R., and Martinez, E. (2006). Development of conventional passenger cab car end structure designs for full scale testing. Technical report.
- [24] Milho, J., Ambrósio, J. A., and Pereira, M. F. (2003). Validated multibody model for train crash analysis. *International journal of crashworthiness*, 8(4):339–352.
- [25] O’Dwyer, A. (2009). *Handbook of PI and PID controller tuning rules*, volume 57. World Scientific.
- [26] Stringfellow, R. and Liana, P. (2007). Detailed Modeling of the Train-to-Train Impact Test. *Federal Railroad Administration Final Report*.
- [27] Stringfellow, R., Rancatore, R., Llana, P., and Mayville, R. (2004). Analysis of colliding vehicle interactions for the passenger rail train-to-train impact test. In *Rail Conference, 2004. Proceedings of the 2004 ASME/IEEE Joint*, pages 11–18. IEEE.
- [28] Taniguchi, M. (1992). High speed rail in Japan: A review and evaluation of the Shinkansen train. *University of California Transportation Center*.
- [29] Tyrell, D. (2003). Passenger Rail Train-to-Train Impact Test Volume I: Overview and Selected Results. Technical report.
- [30] Vickerman, R. (1997). High-speed rail in Europe: experience and issues for future development. *The annals of regional science*, 31(1):21–38.
- [31] Wescott, T. (2000). PID without a PhD. *Embedded Systems Programming*, 13(11):1–7.

REFERENCES

- [32] Yuan, X., Merk, W., Stemmler, H., and Allmeling, J. (2002). Stationary-frame generalized integrators for current control of active power filters with zero steady-state error for current harmonics of concern under unbalanced and distorted operating conditions. *IEEE Transactions on Industry Applications*, 38(2):523–532.

VITA AUCTORIS

NAME: Bo Yu
PLACE OF BIRTH: Tianjin, China
YEAR OF BIRTH: 1990
EDUCATION: Tianjing University of Technology, B.Eng., Computer Science and Technology, Tianjin, China, 2013
University of Windsor, M.Sc in Computer Science, Windsor, Ontario, 2016